

ΑΝΑΓΚΗ ΛΟΓΟΣ

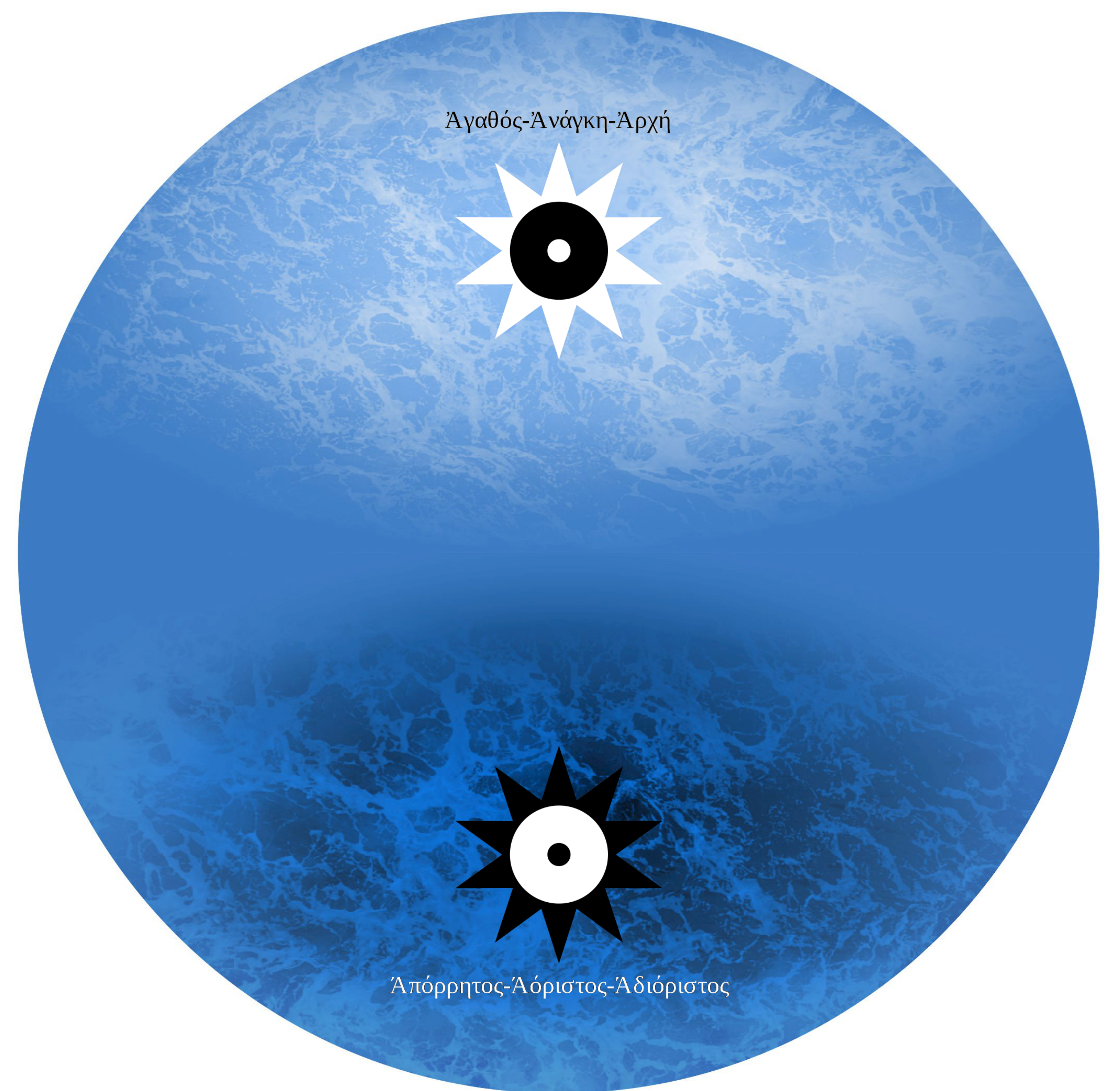

EDM(Electricity) EDM(Dielectricity) DMG(Gravity or Mass) MGE(Atomic Motion) GED(Radial Inertia) GEM(Spherical Force Discharge) GED(Spherical Inertial Charge) EDG(Dielectric Hysteresis) EMG(Magnetic Hysteresis) DEG(Electric Solar Acceleration) DEM(Aether Hysteresis)

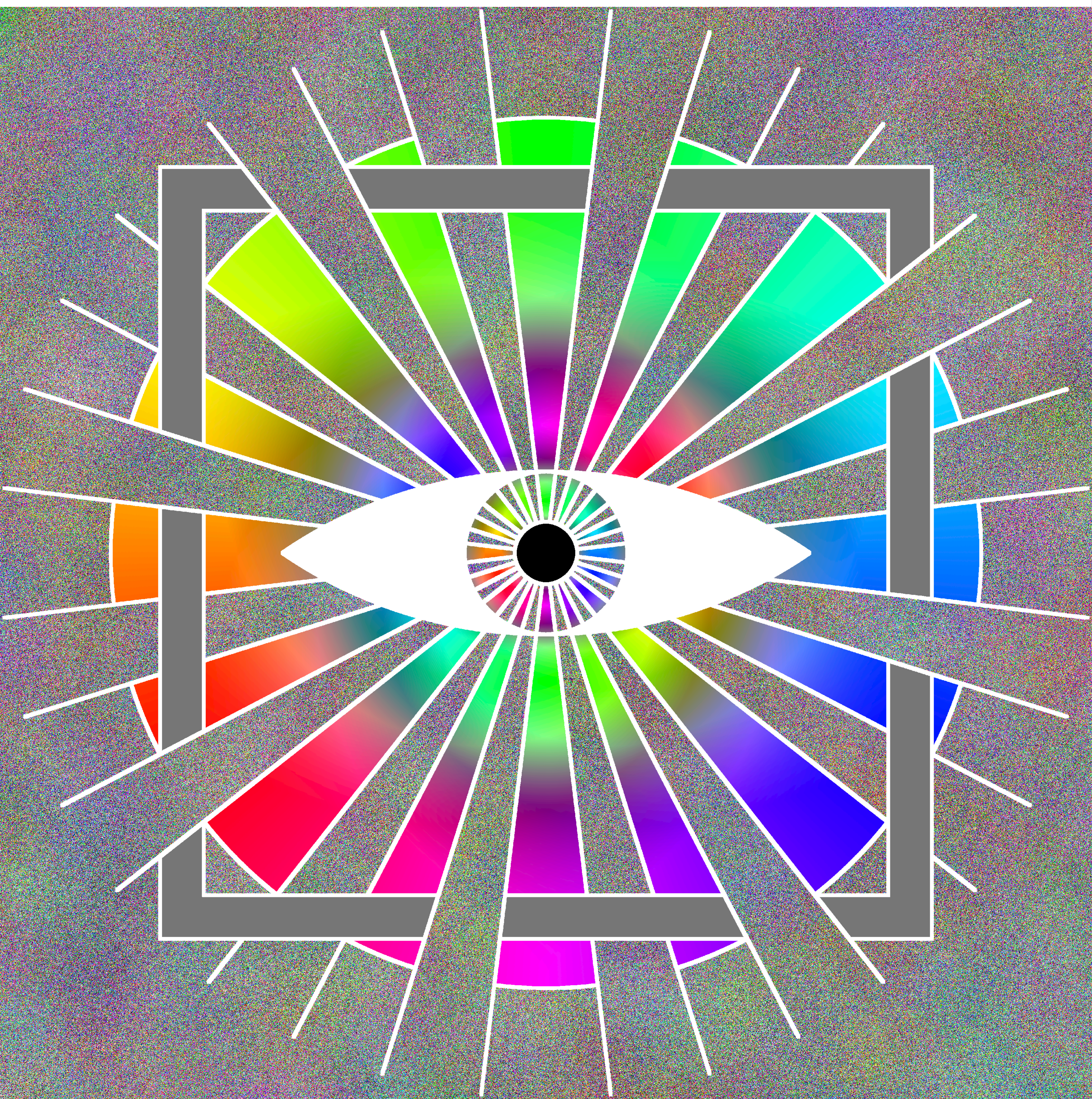
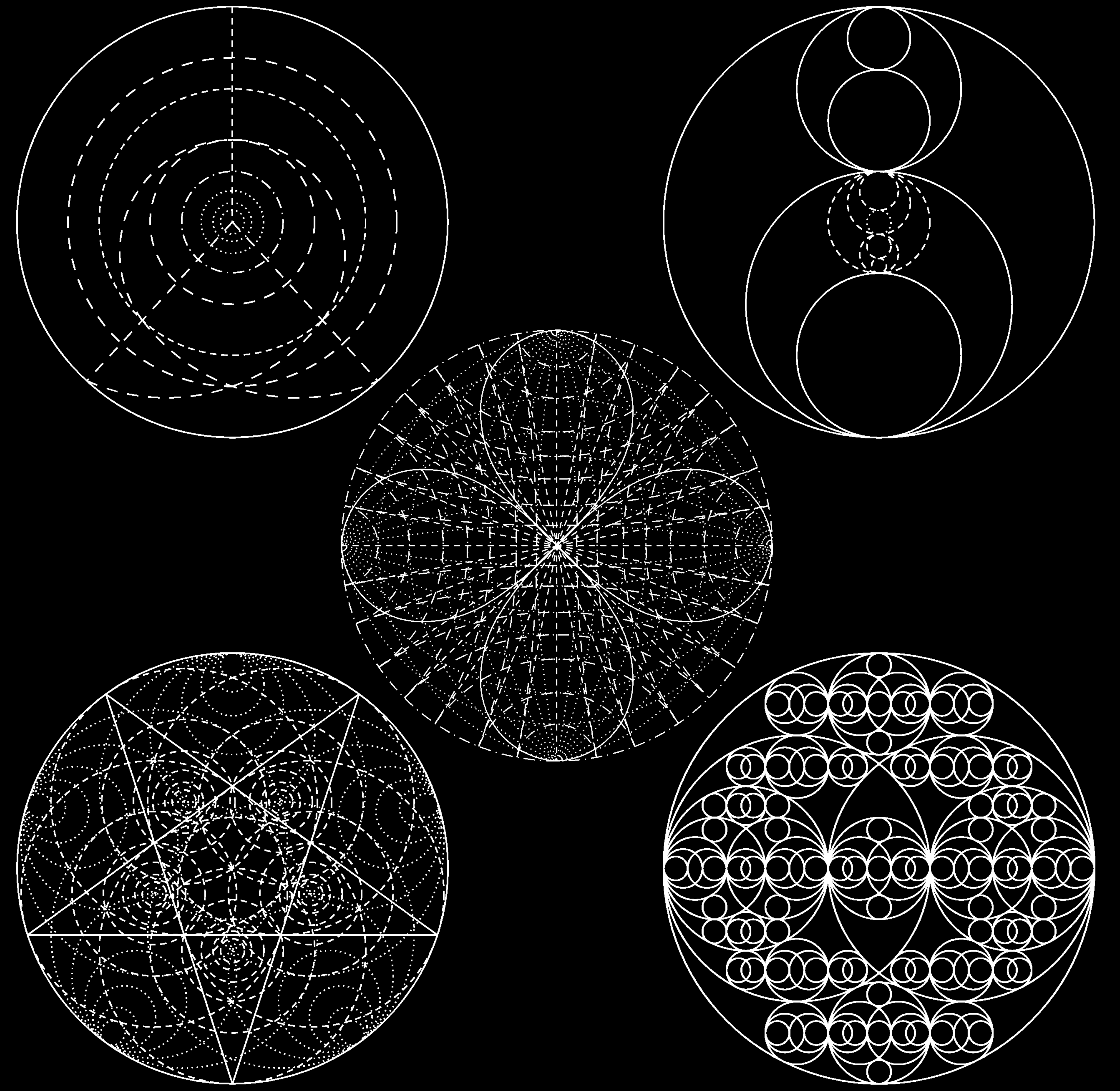
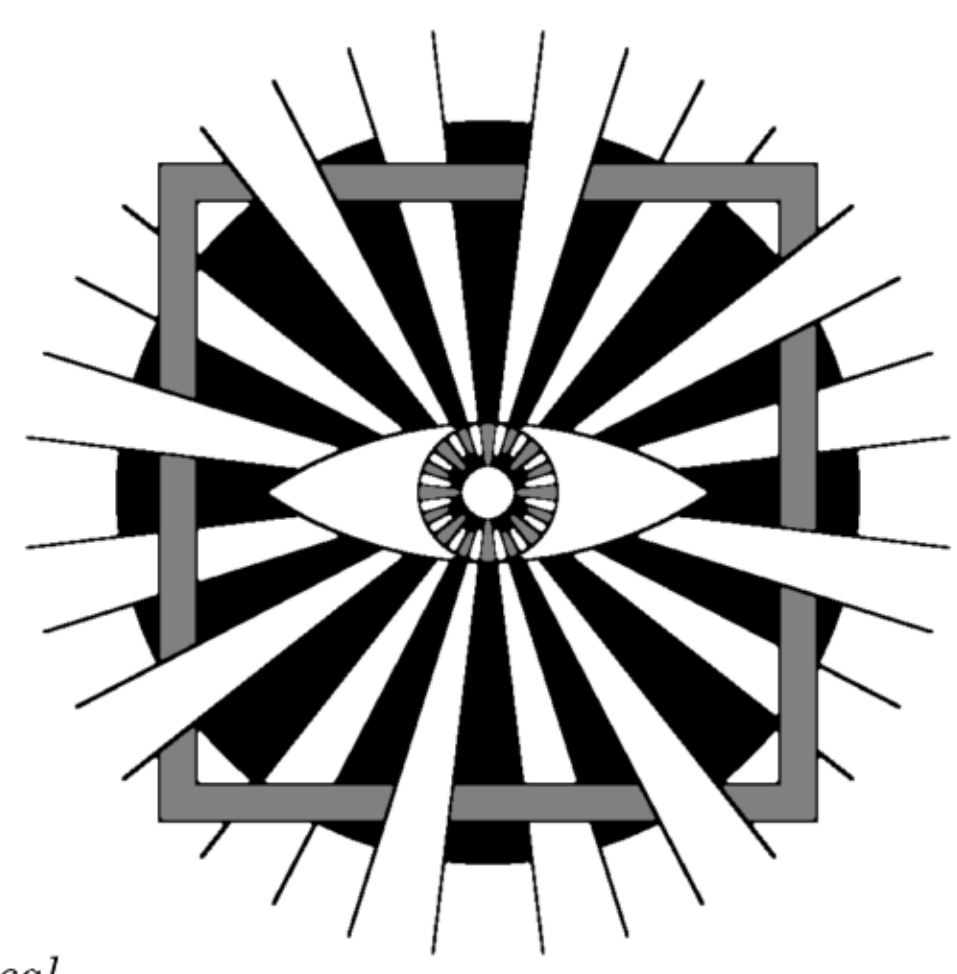
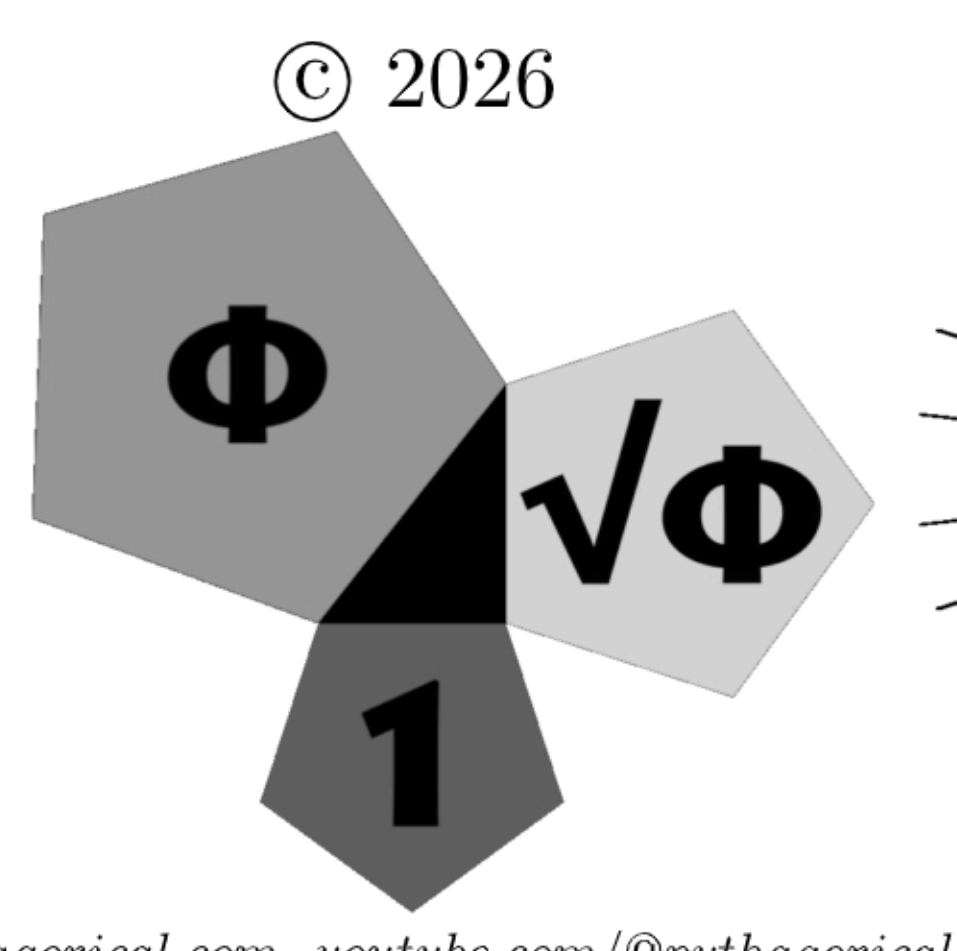
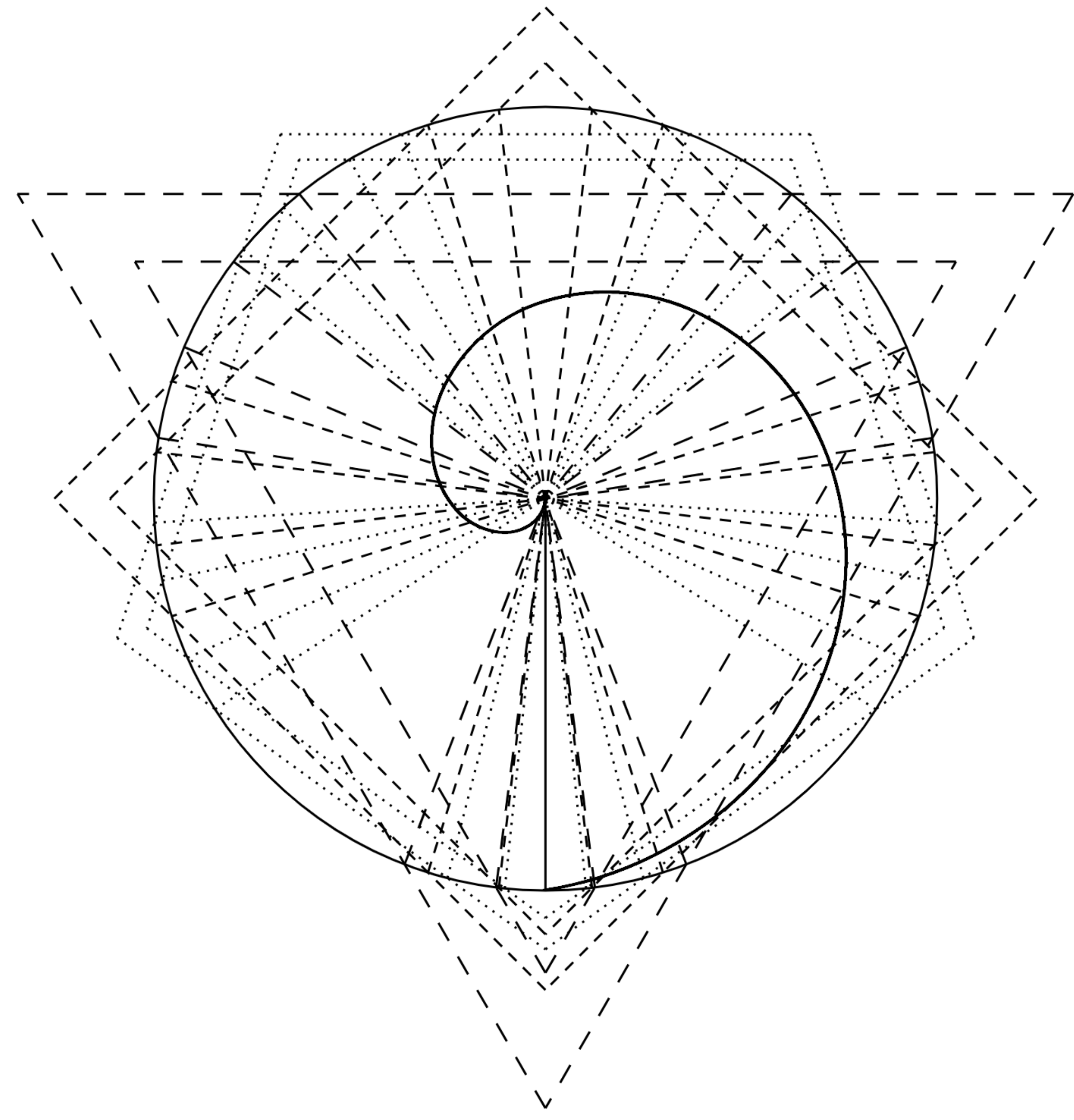
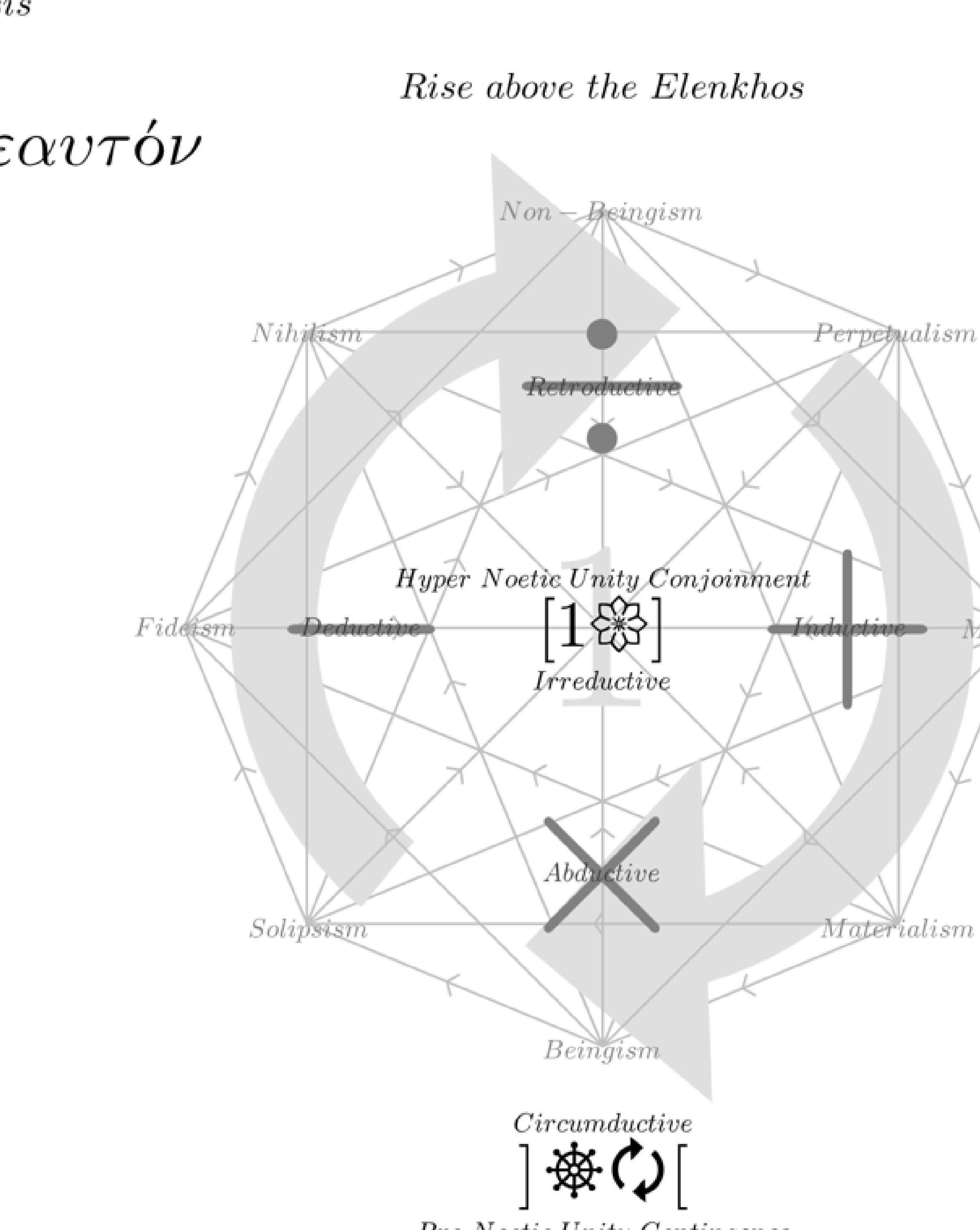
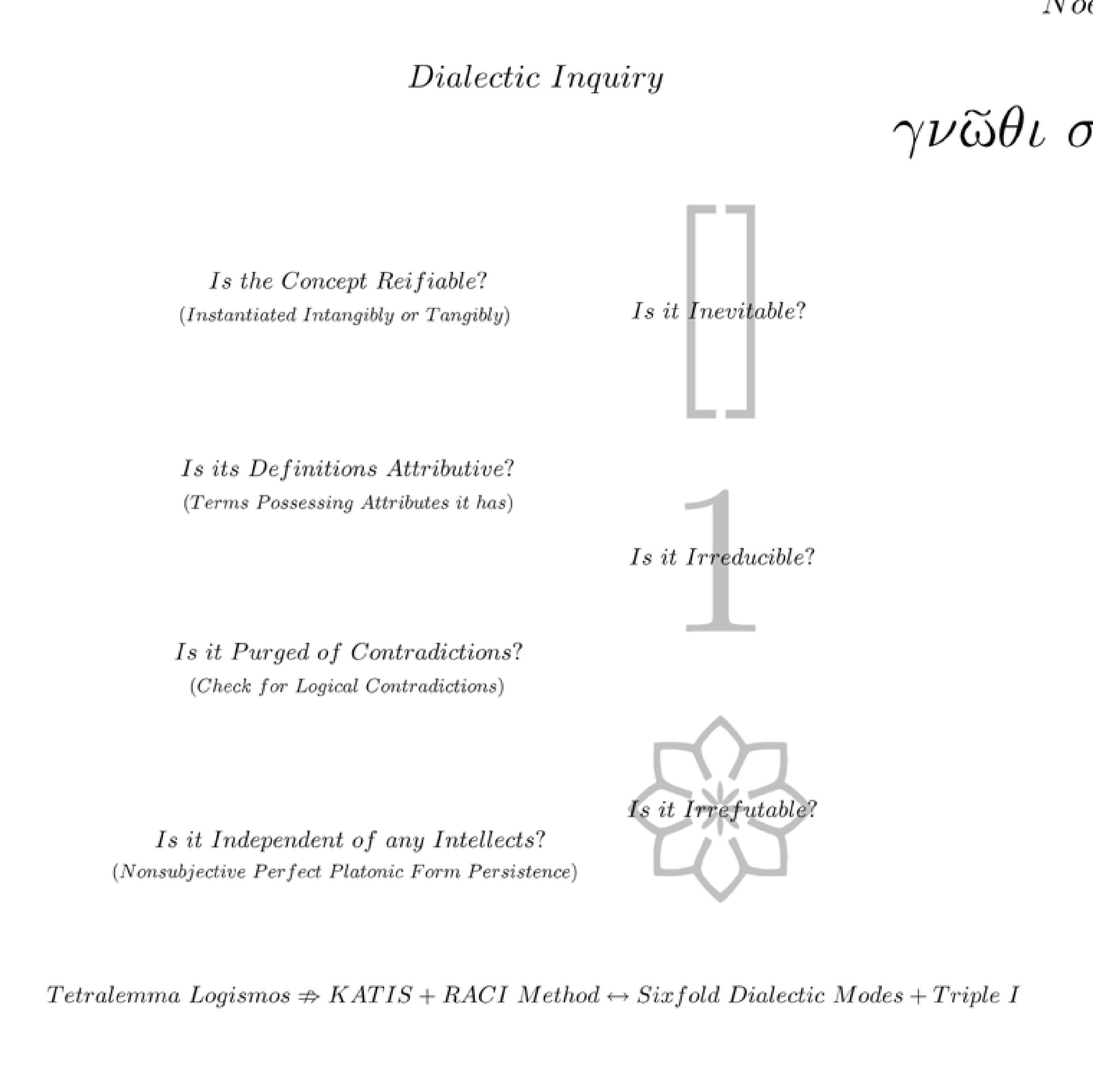
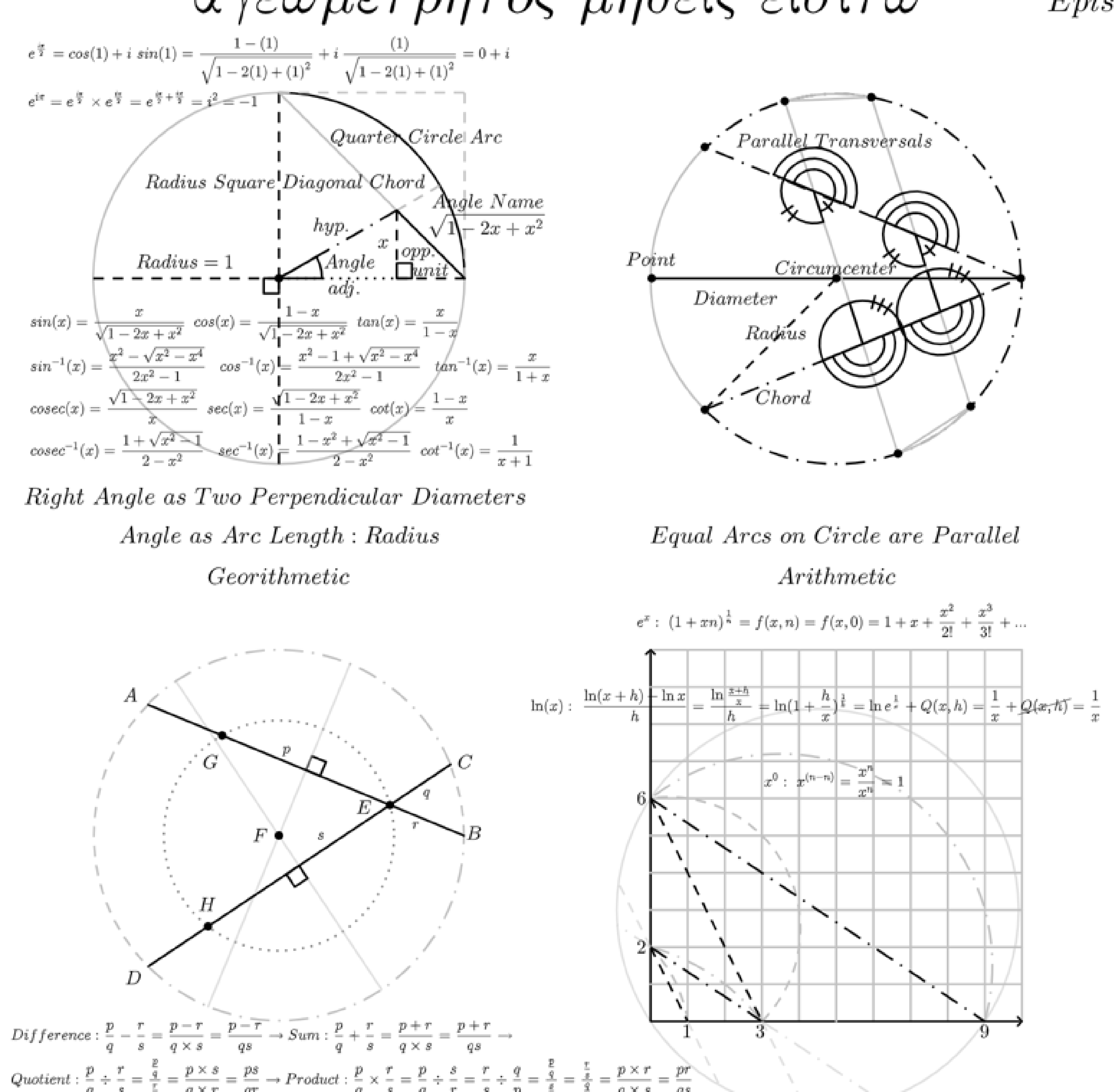
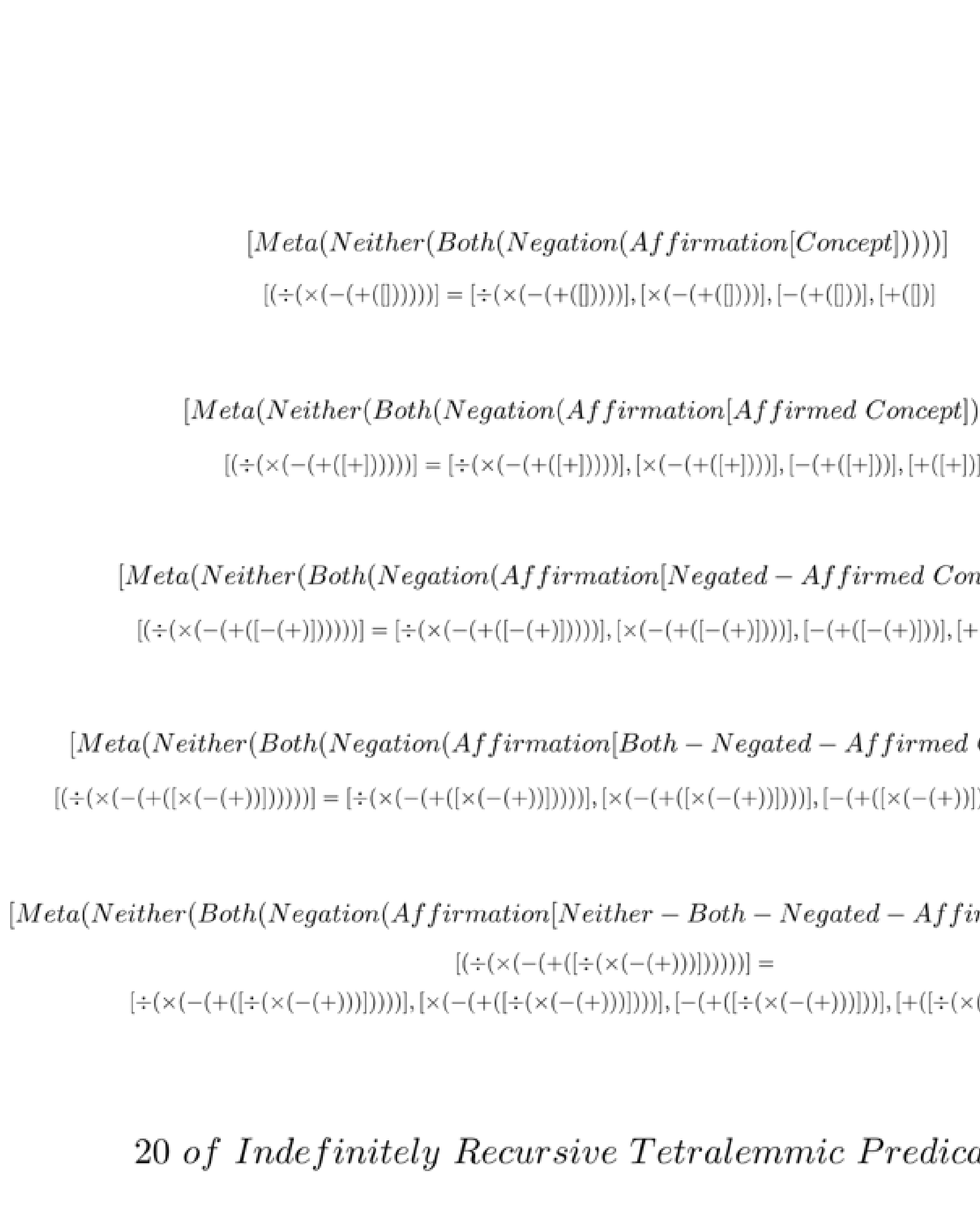
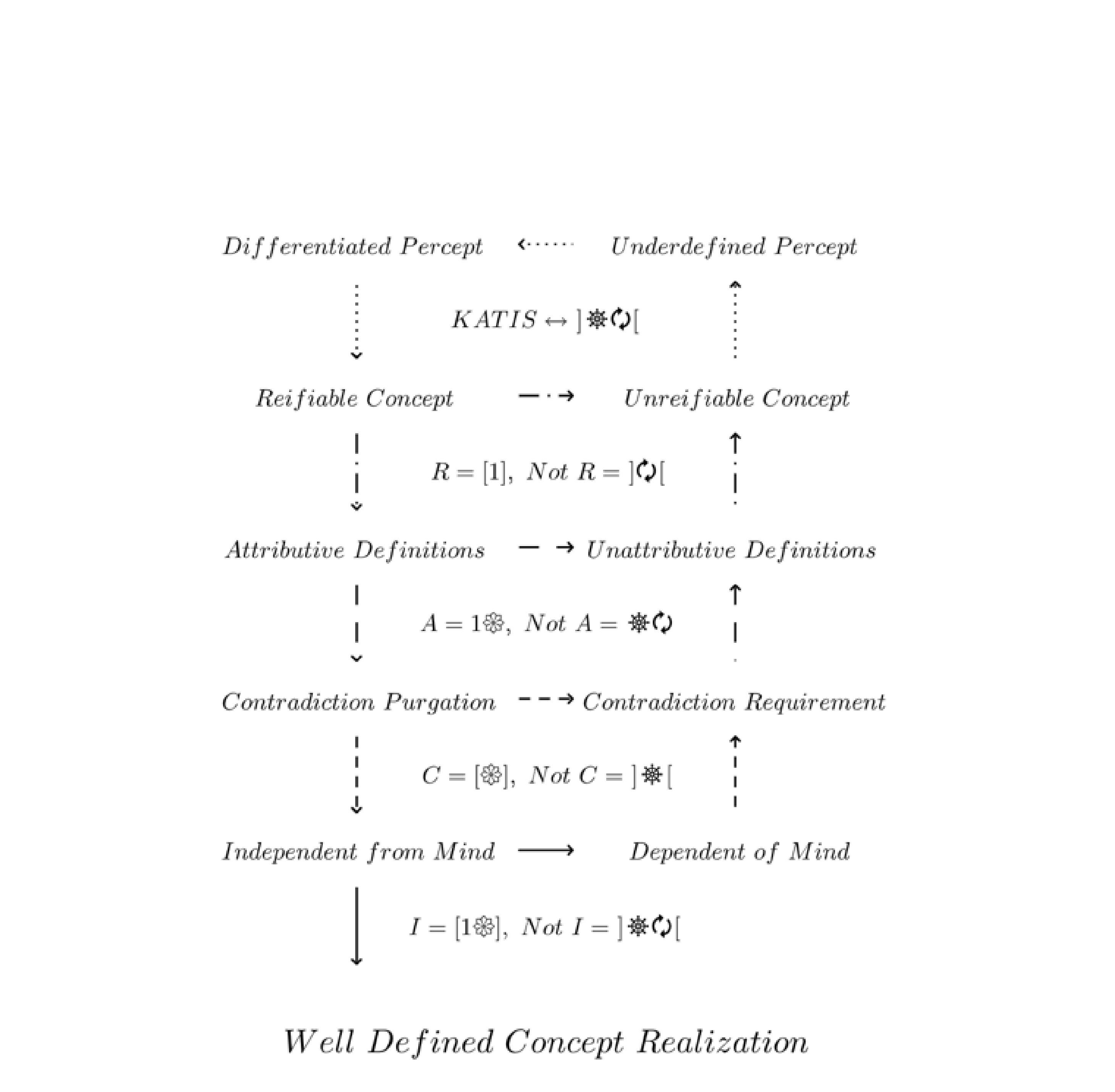
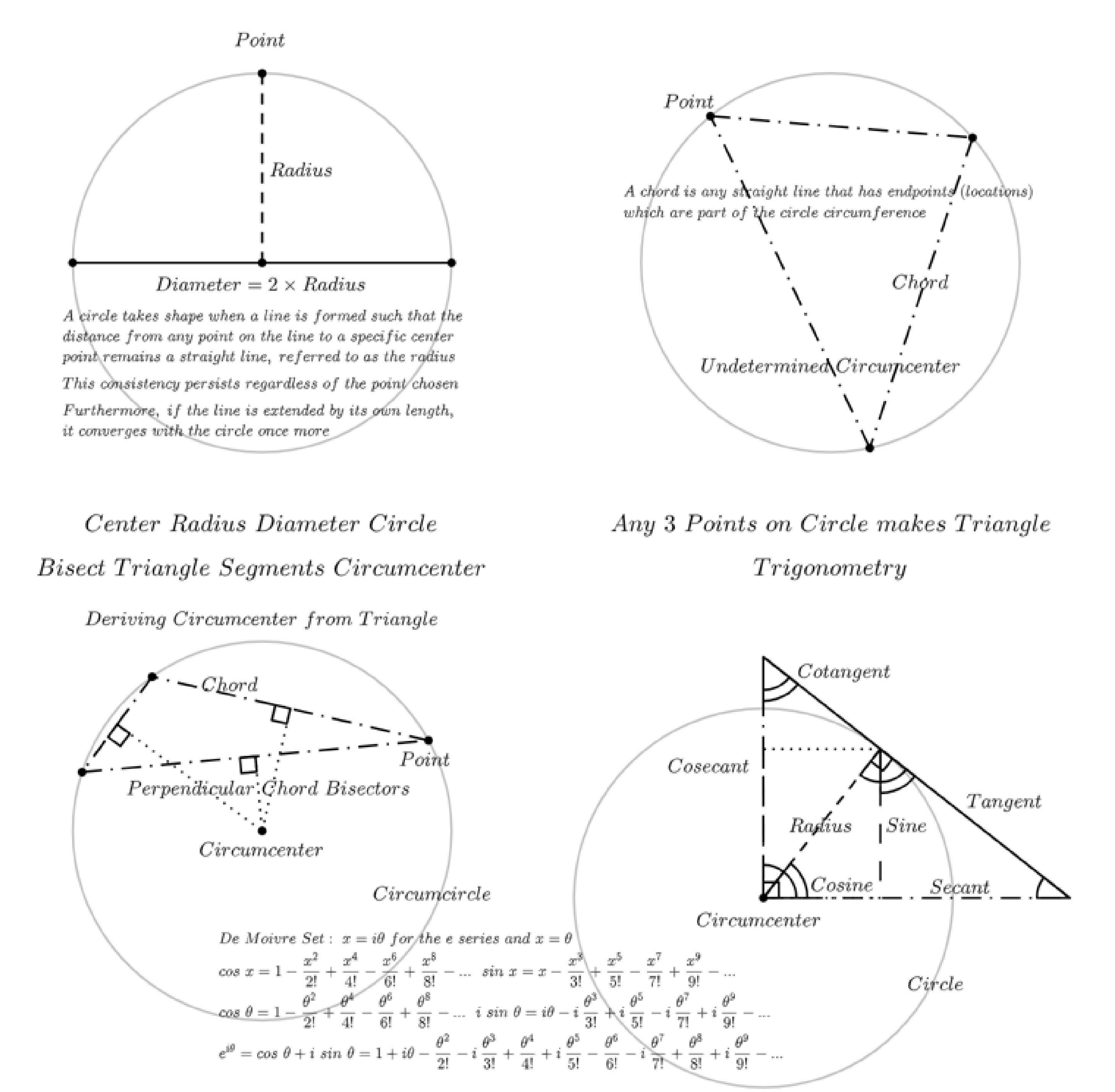
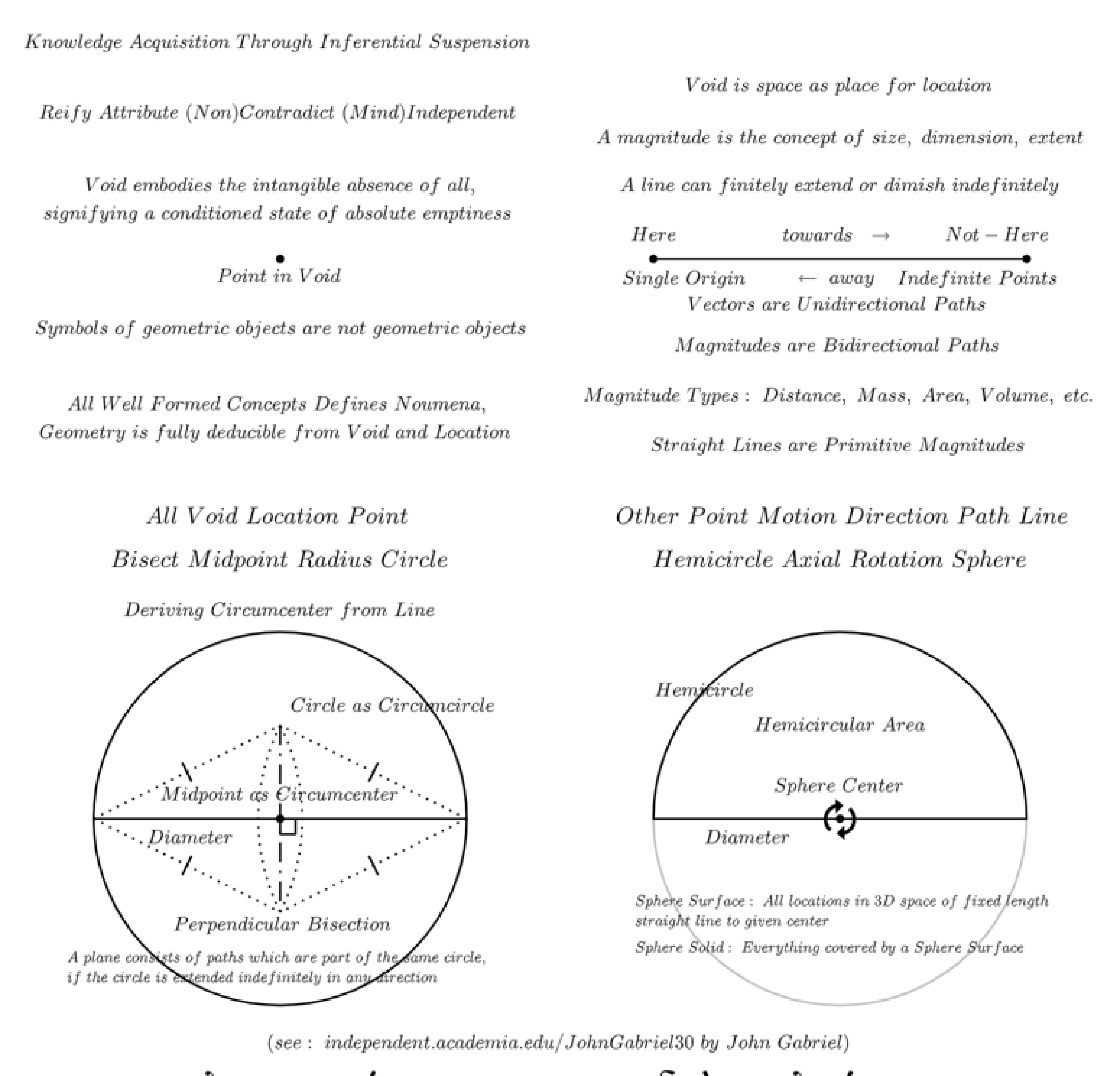
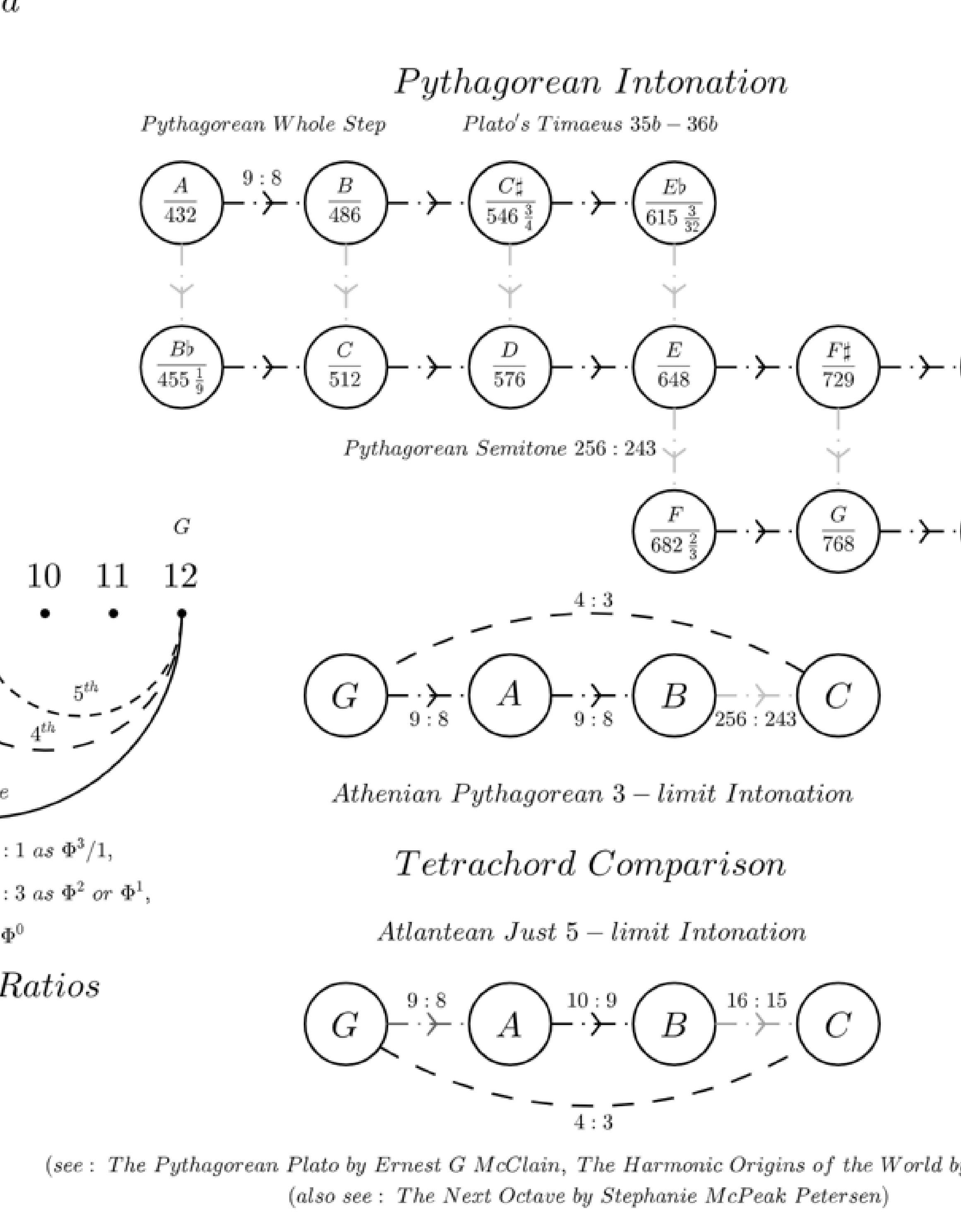
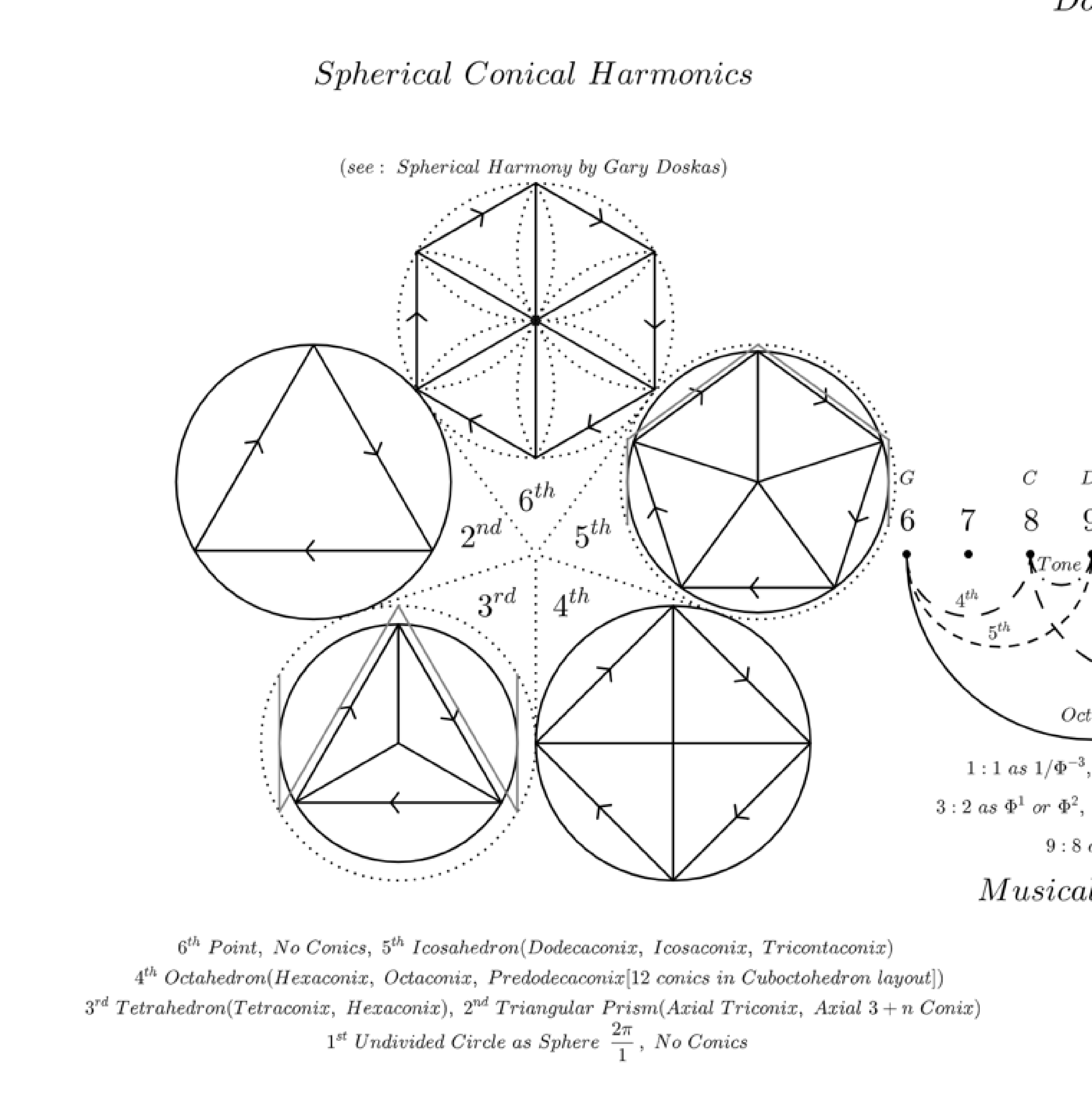
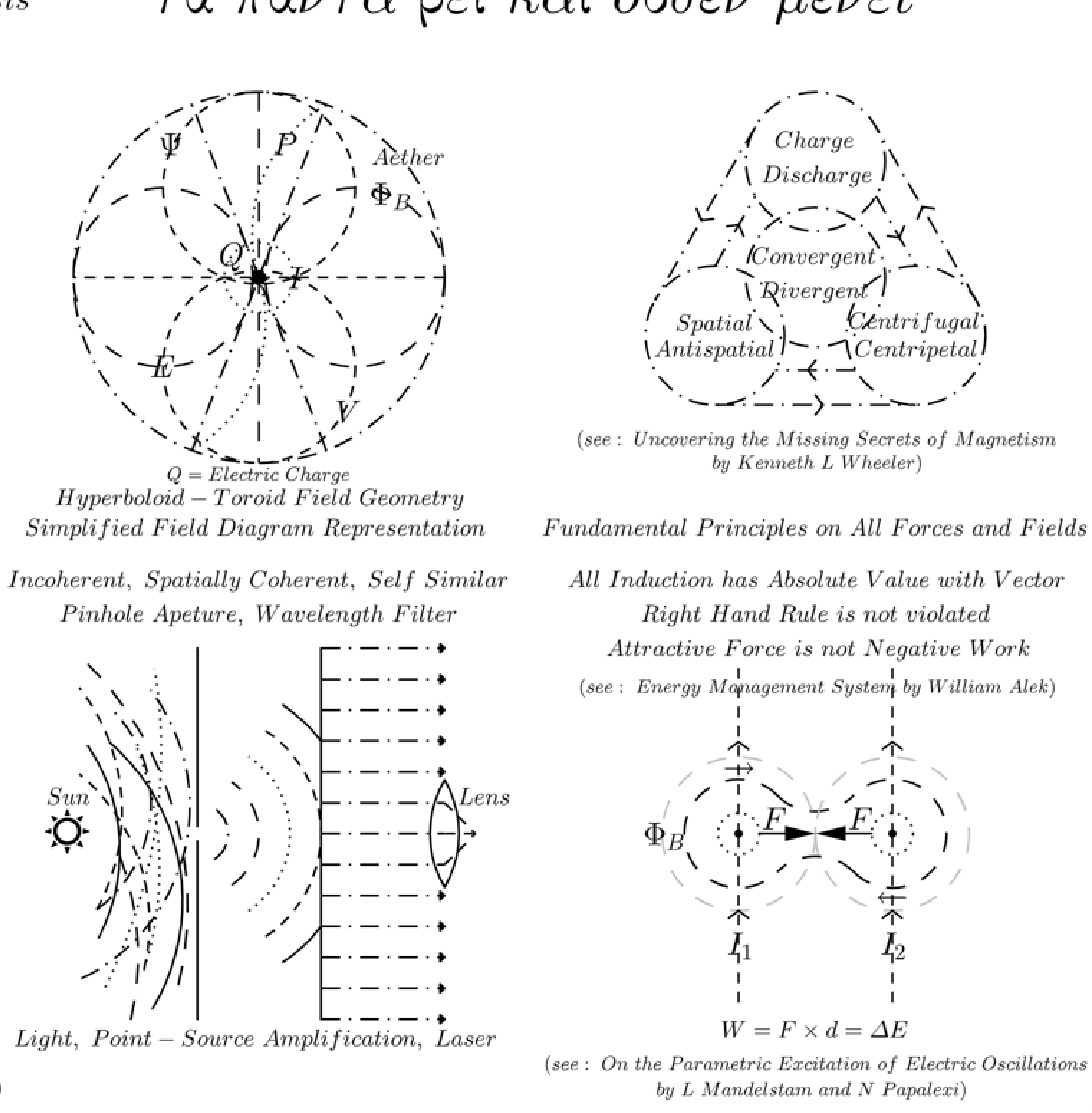
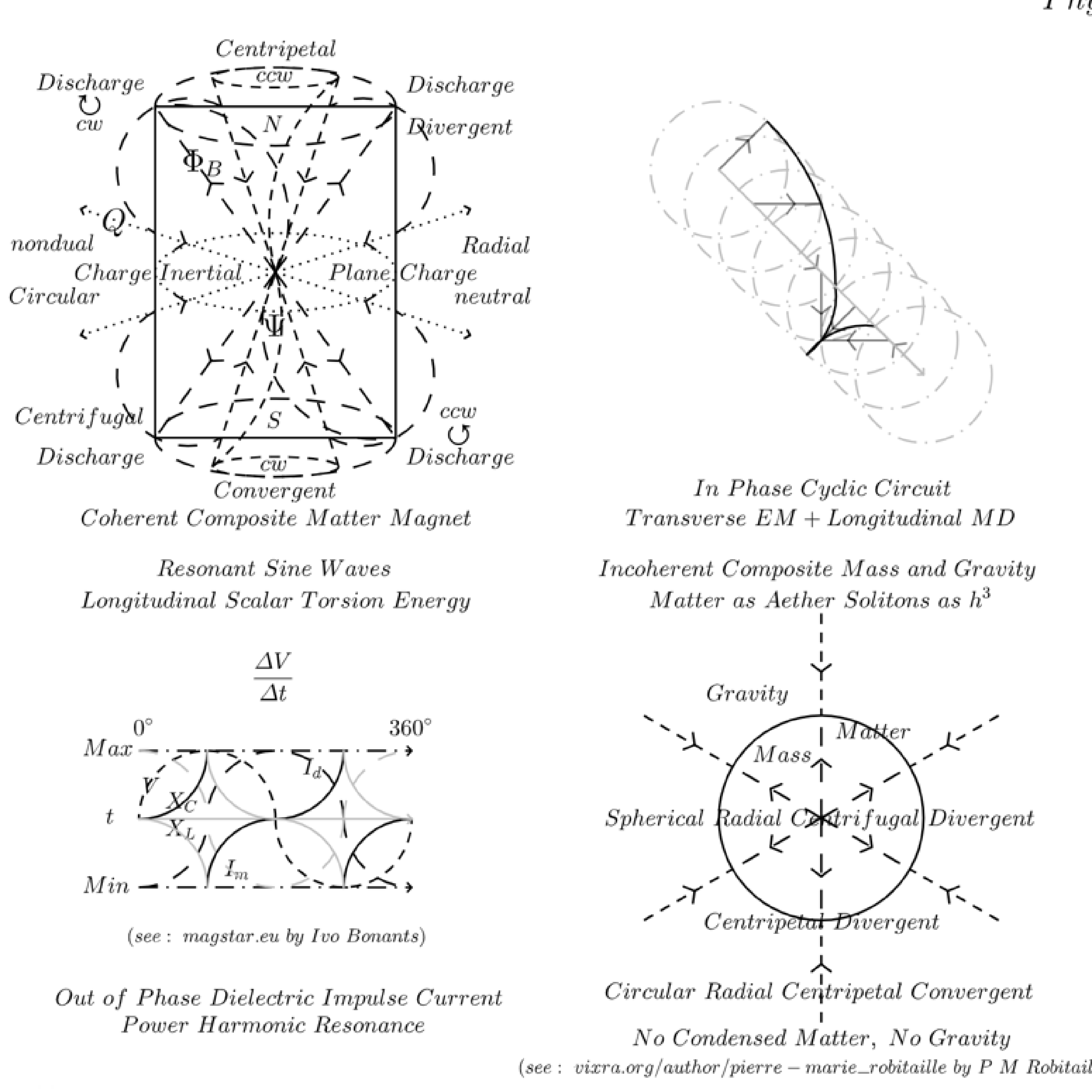
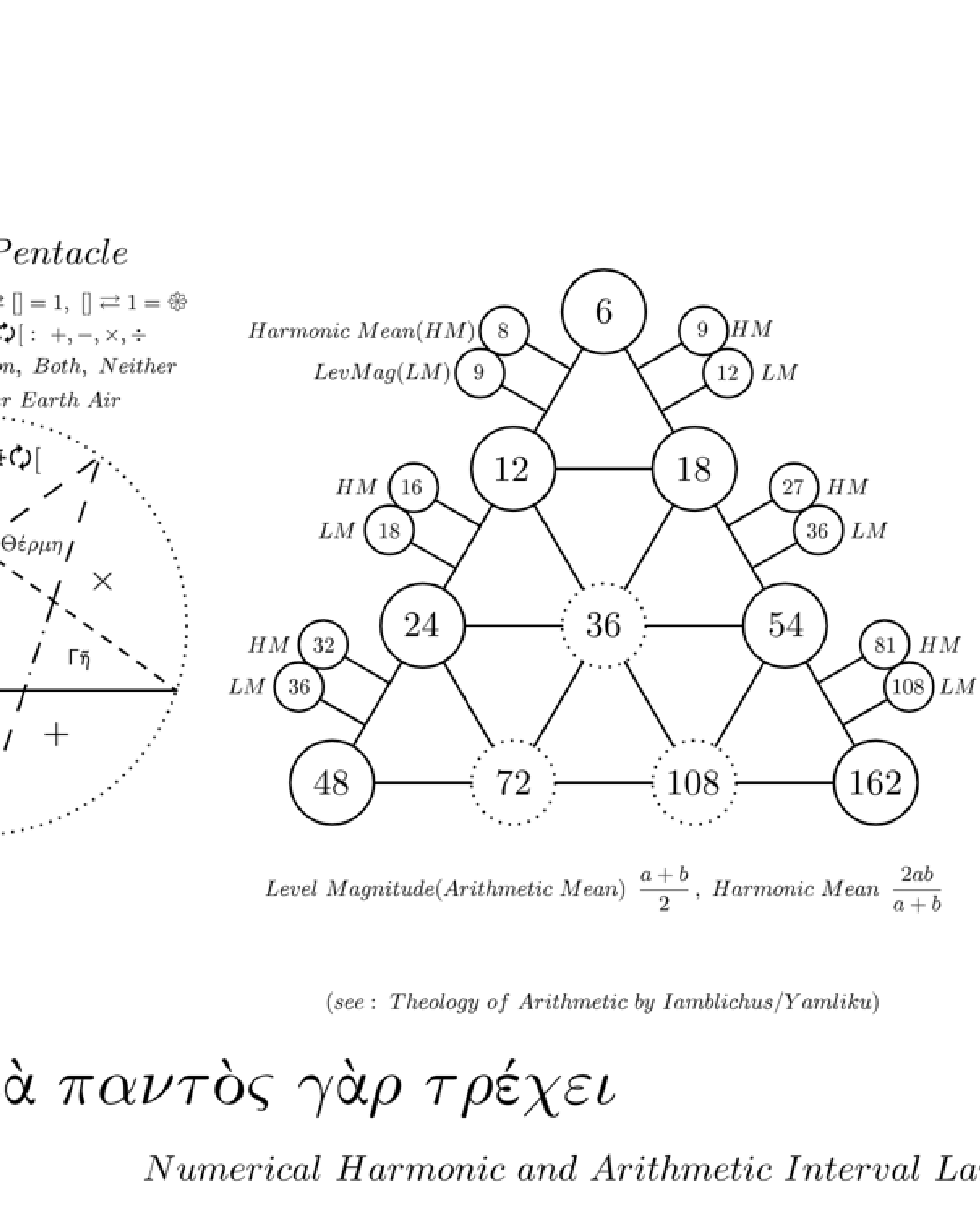
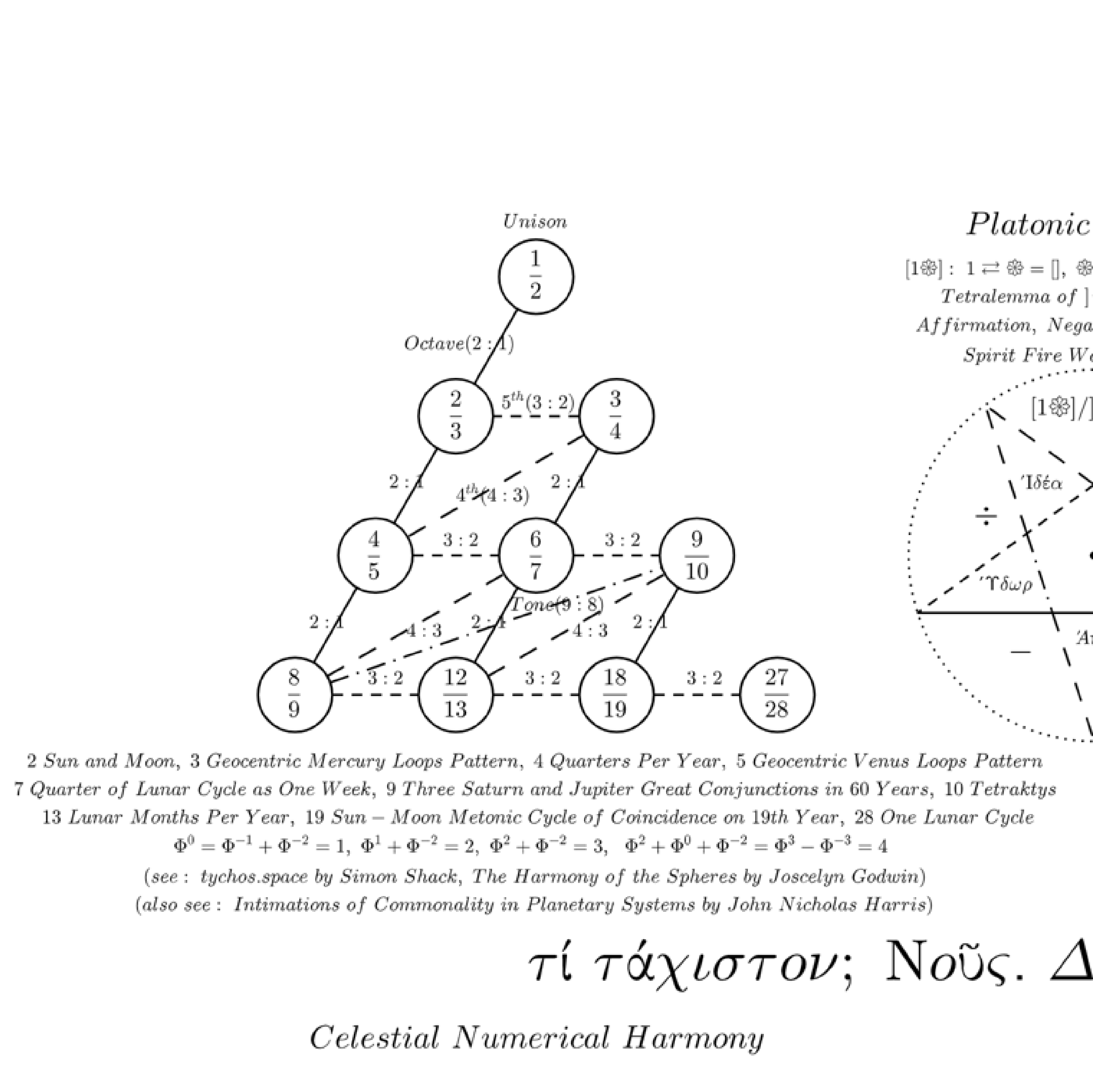
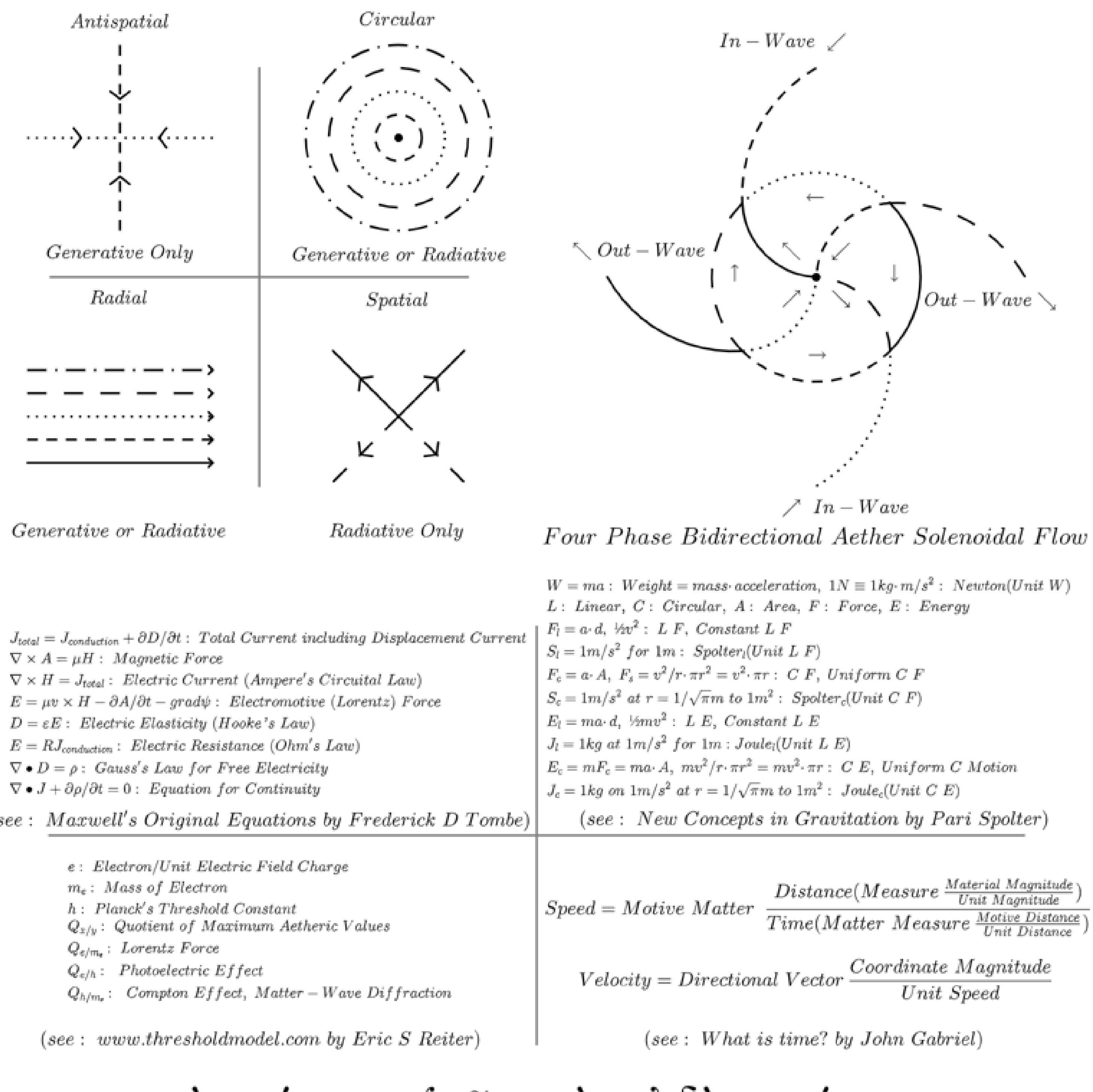
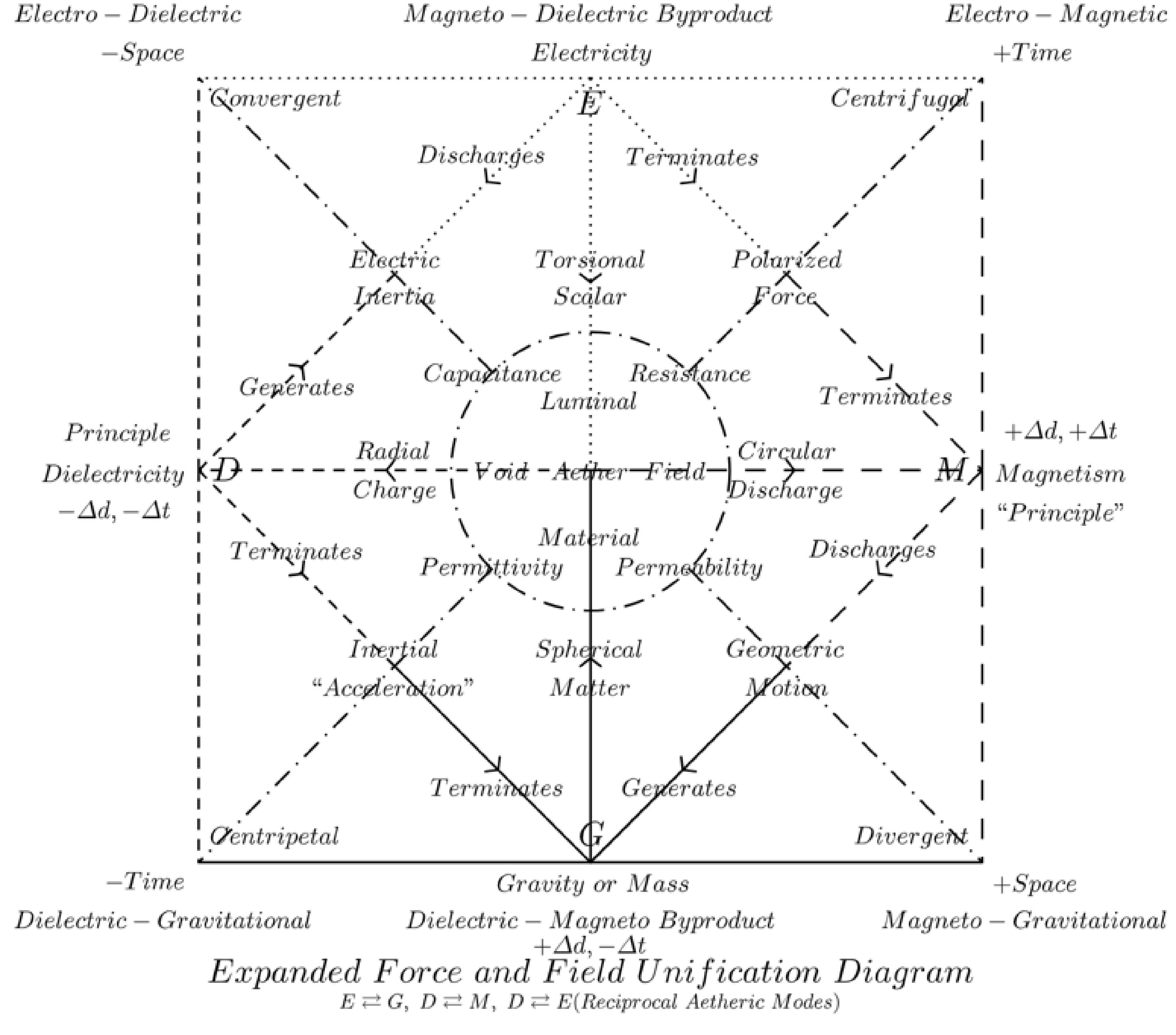

Difference: $\frac{p}{q} - \frac{r}{s} = \frac{ps - rq}{qs}$ Sum: $\frac{p}{q} + \frac{r}{s} = \frac{ps + rq}{qs}$ Product: $\frac{p}{q} \times \frac{r}{s} = \frac{pr}{qs}$ Quotient: $\frac{p}{q} \div \frac{r}{s} = \frac{ps}{qr}$

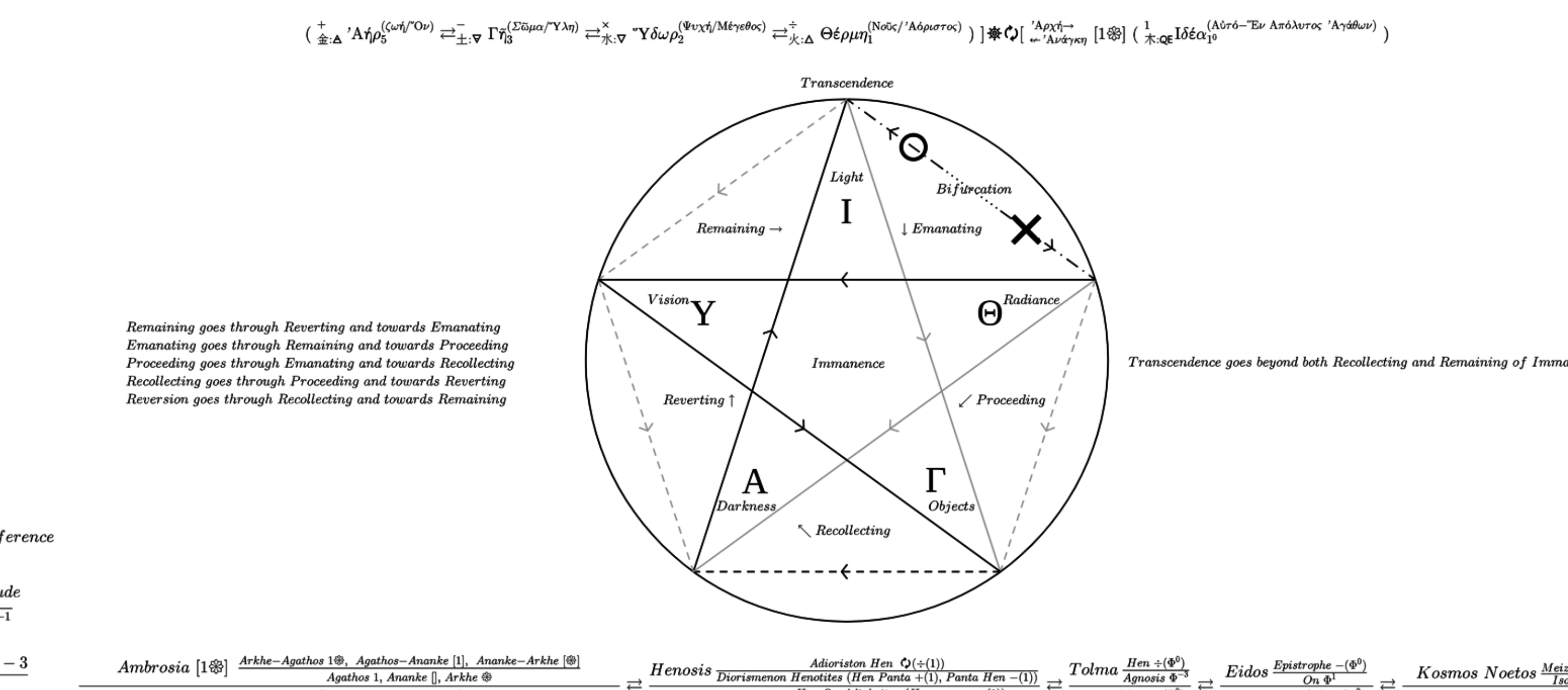
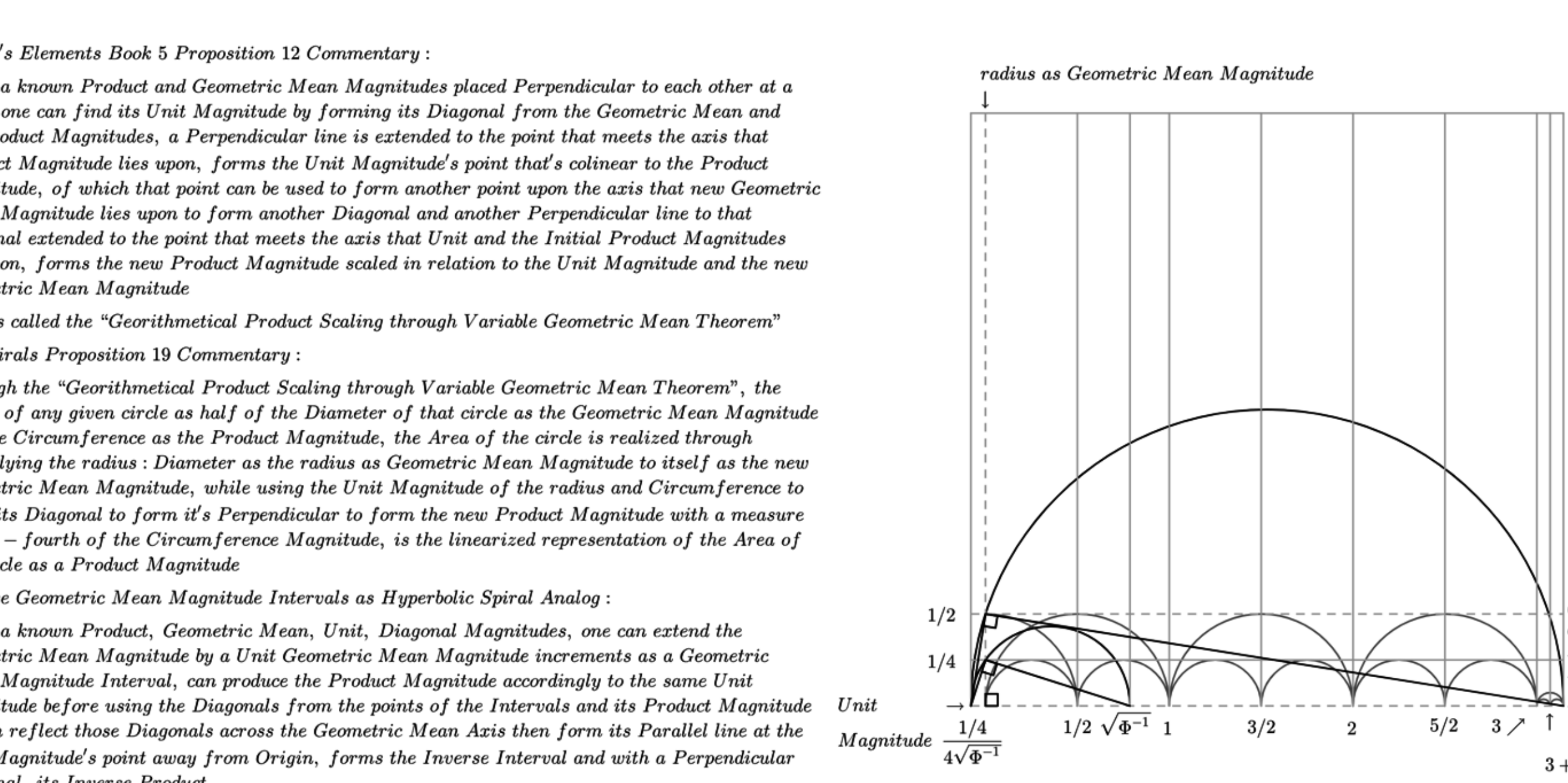
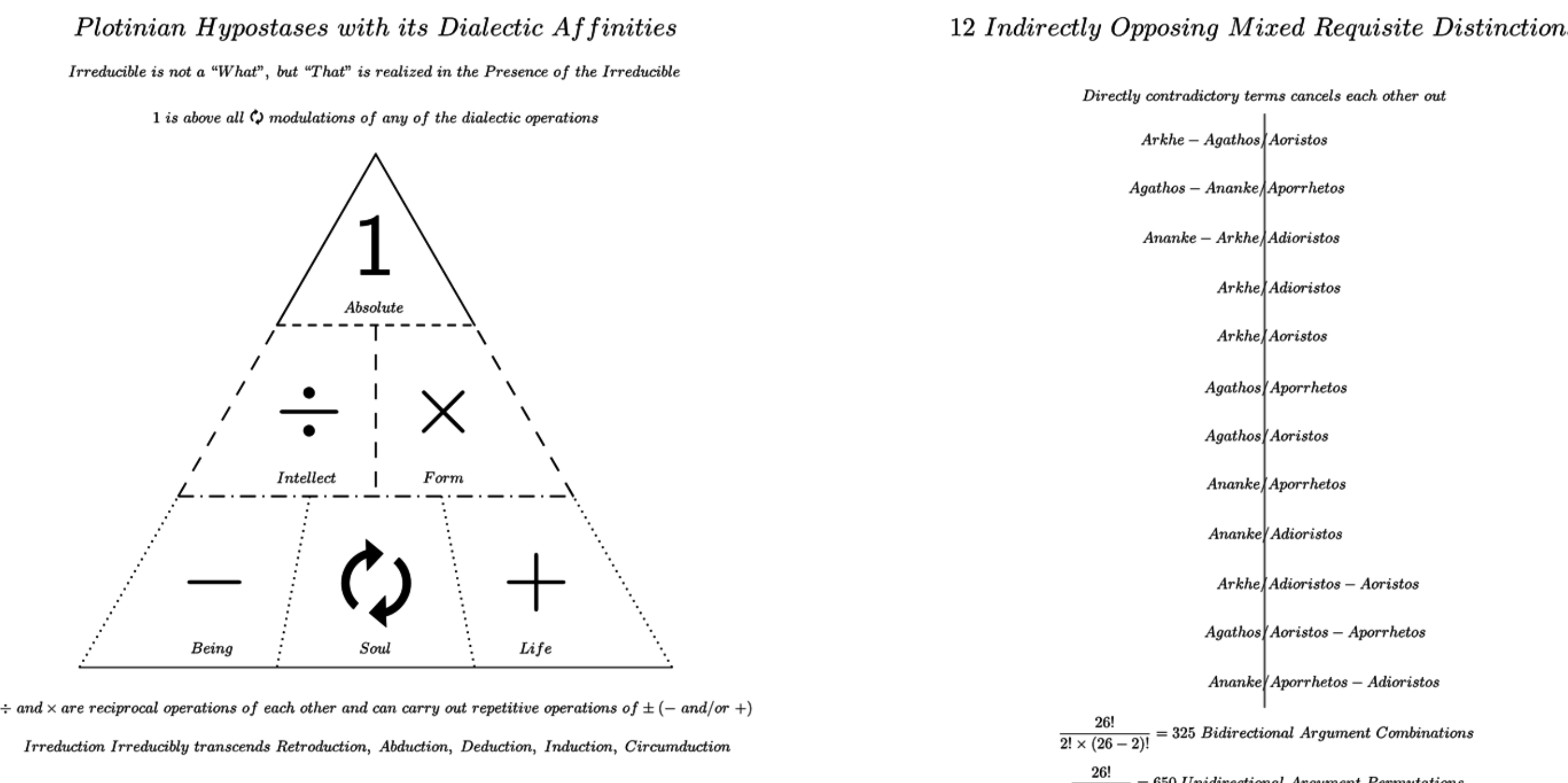
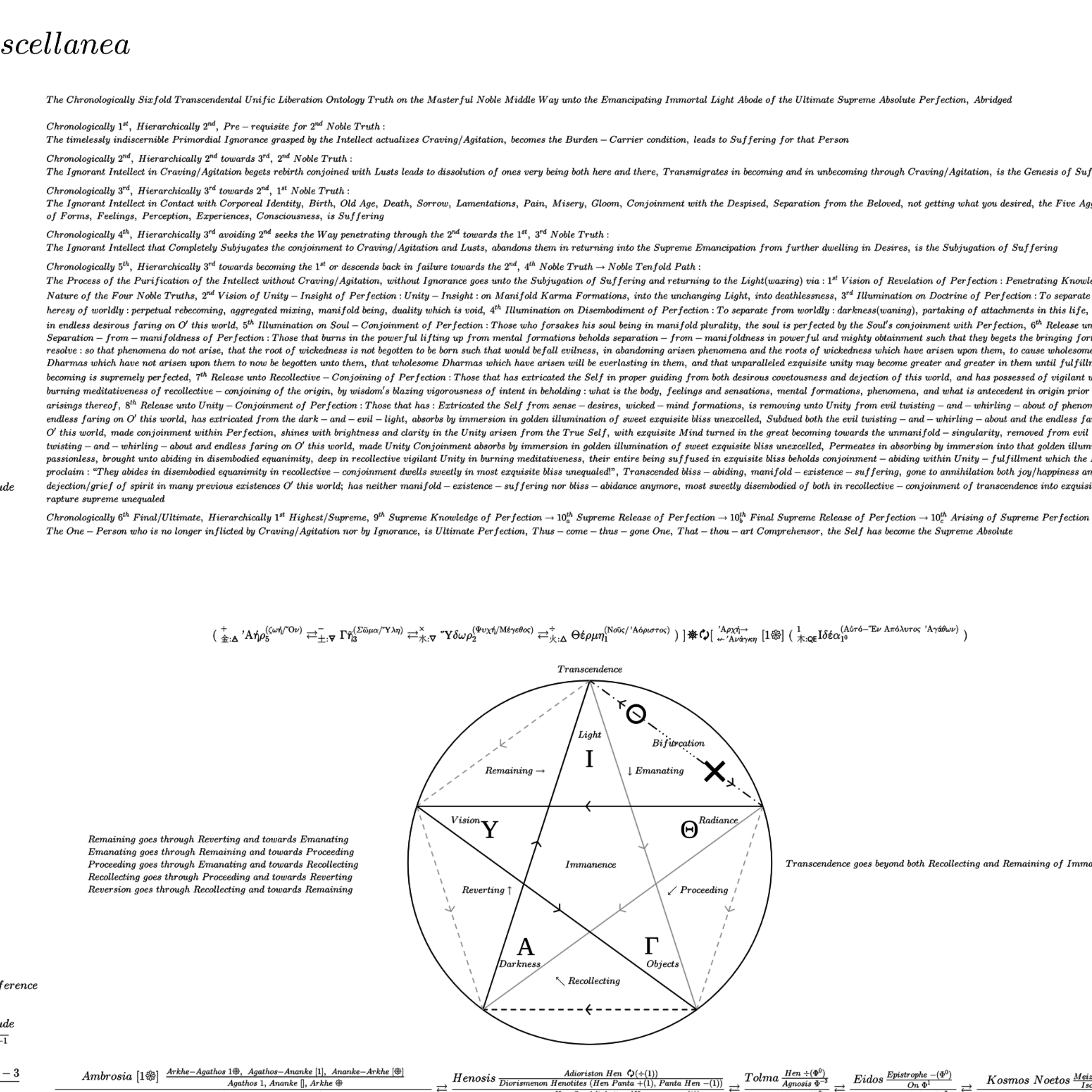
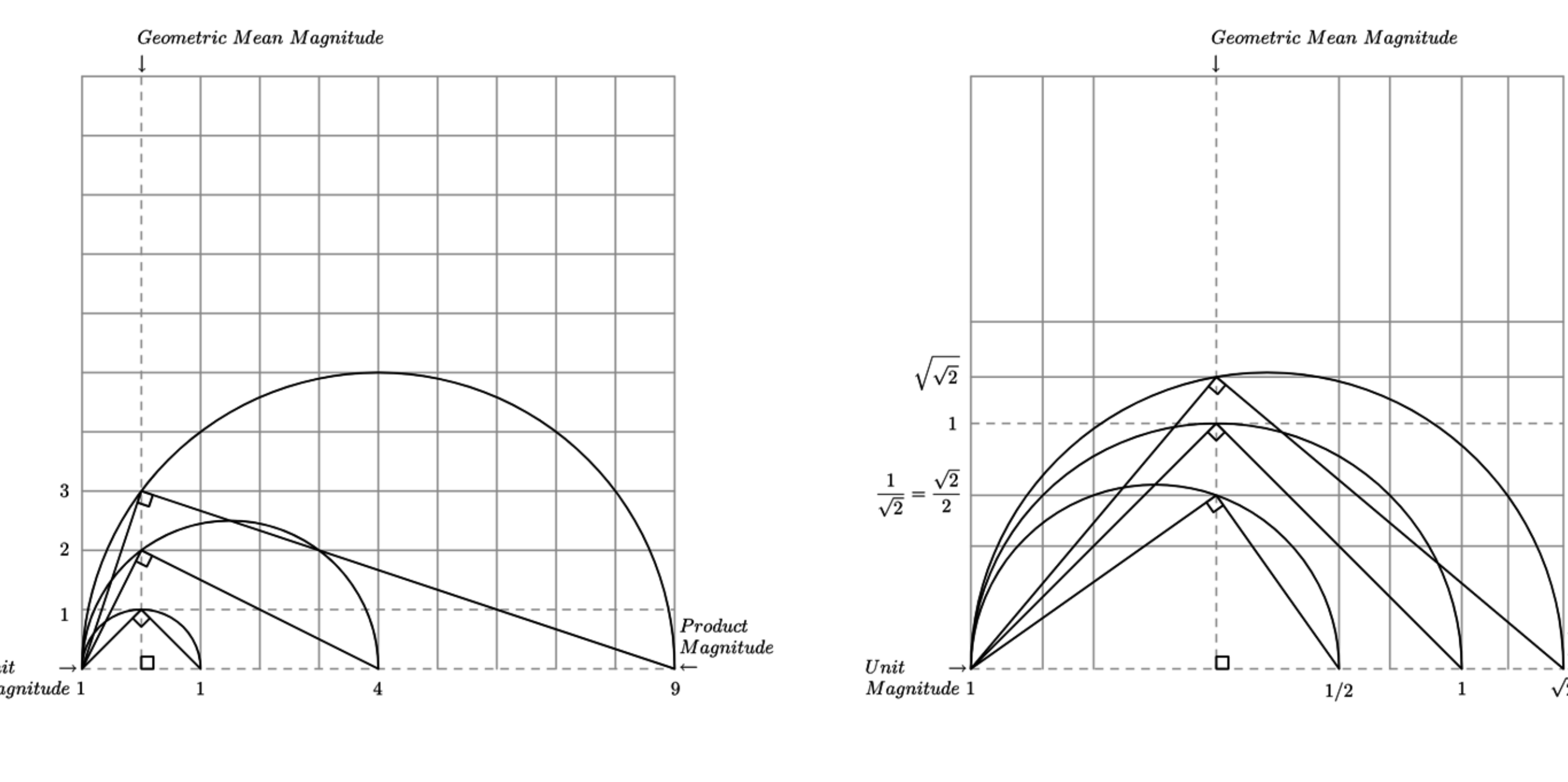
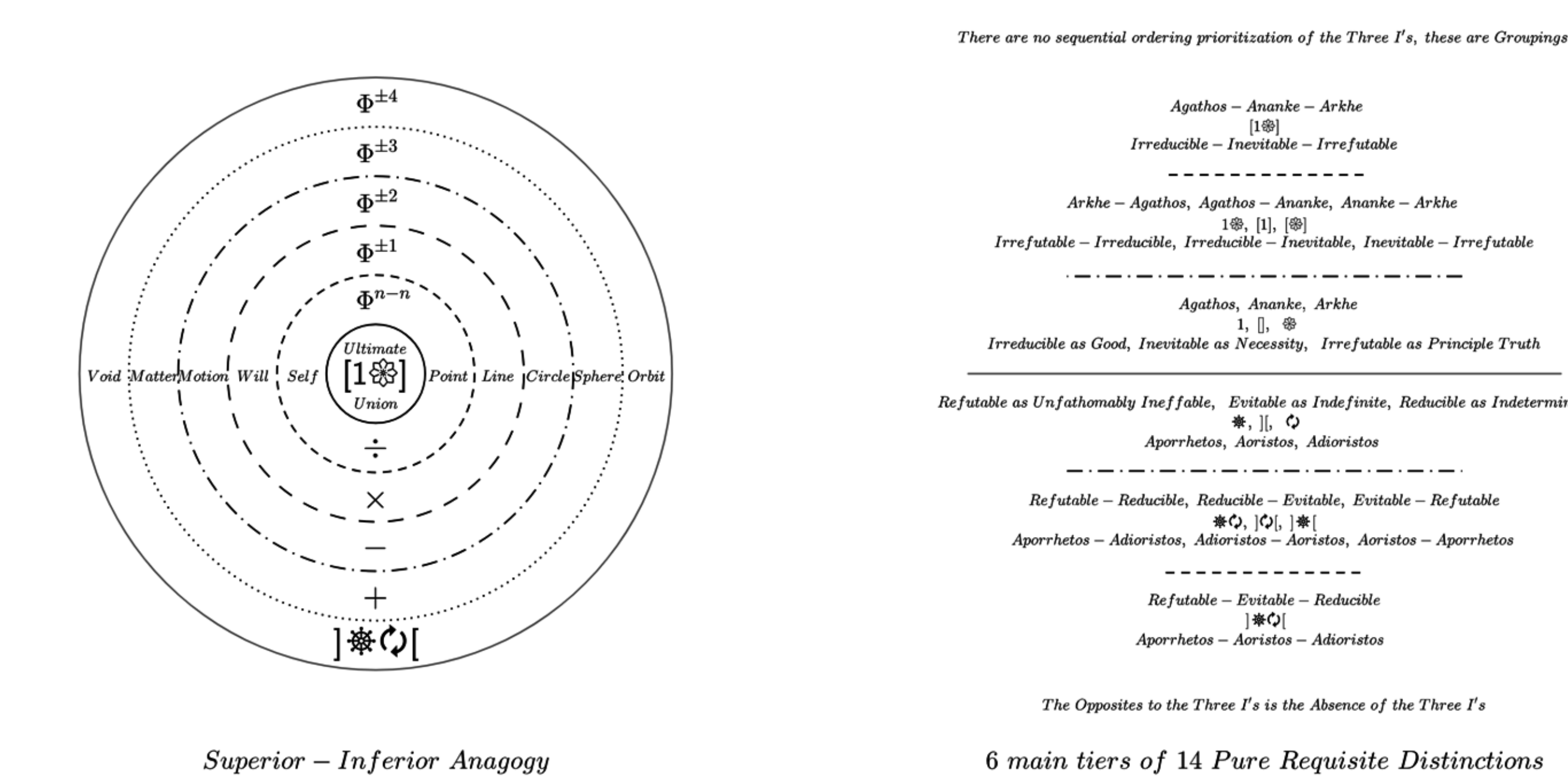
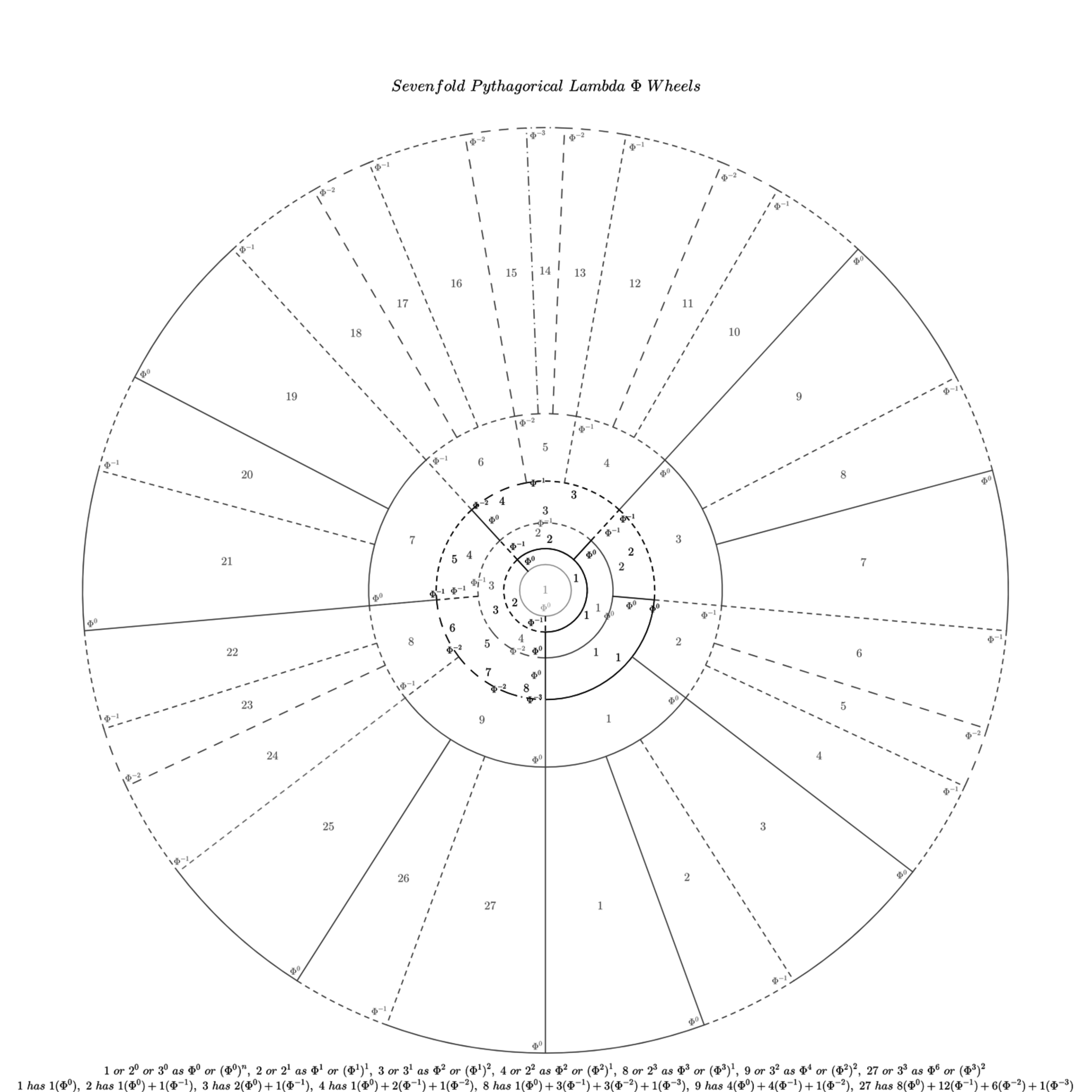
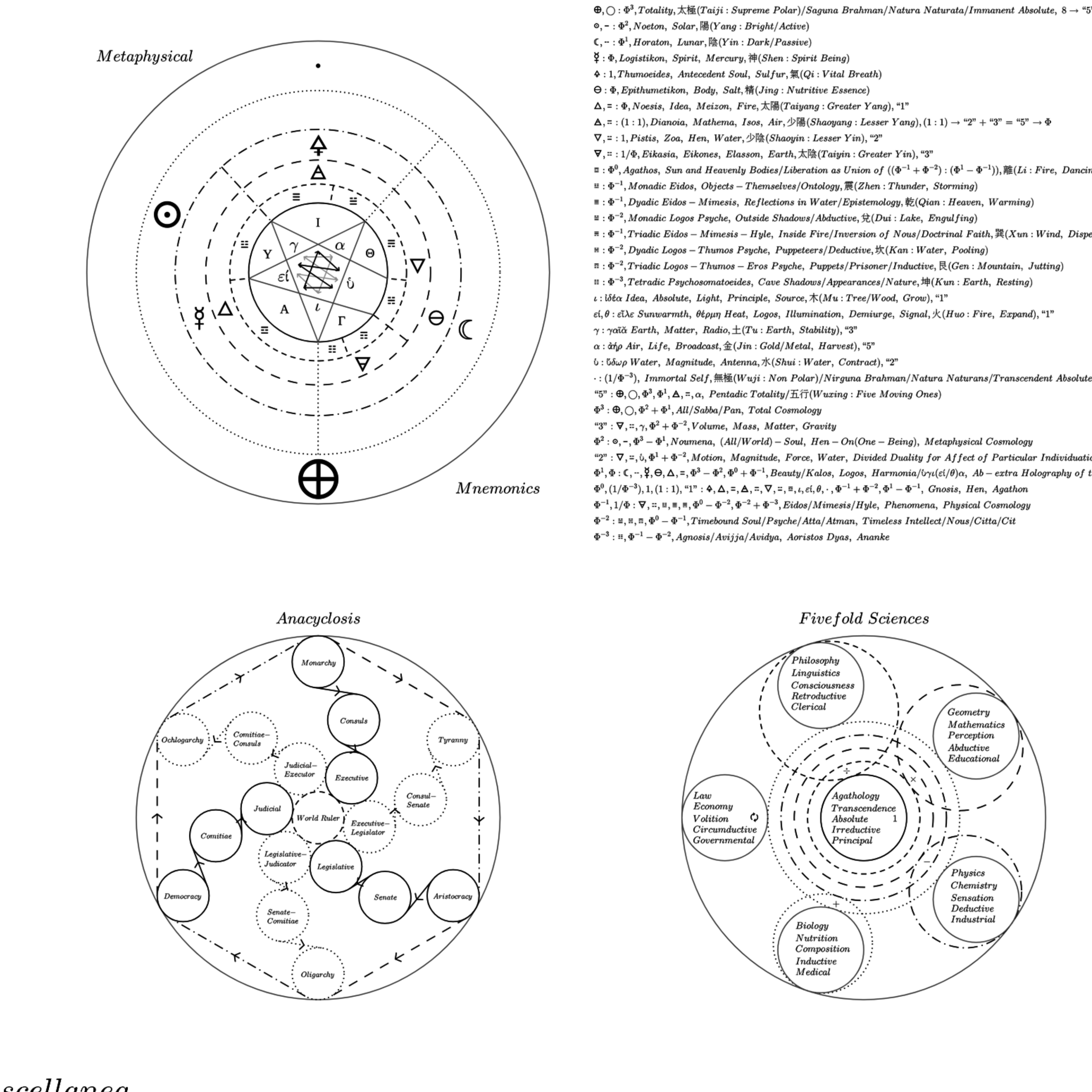
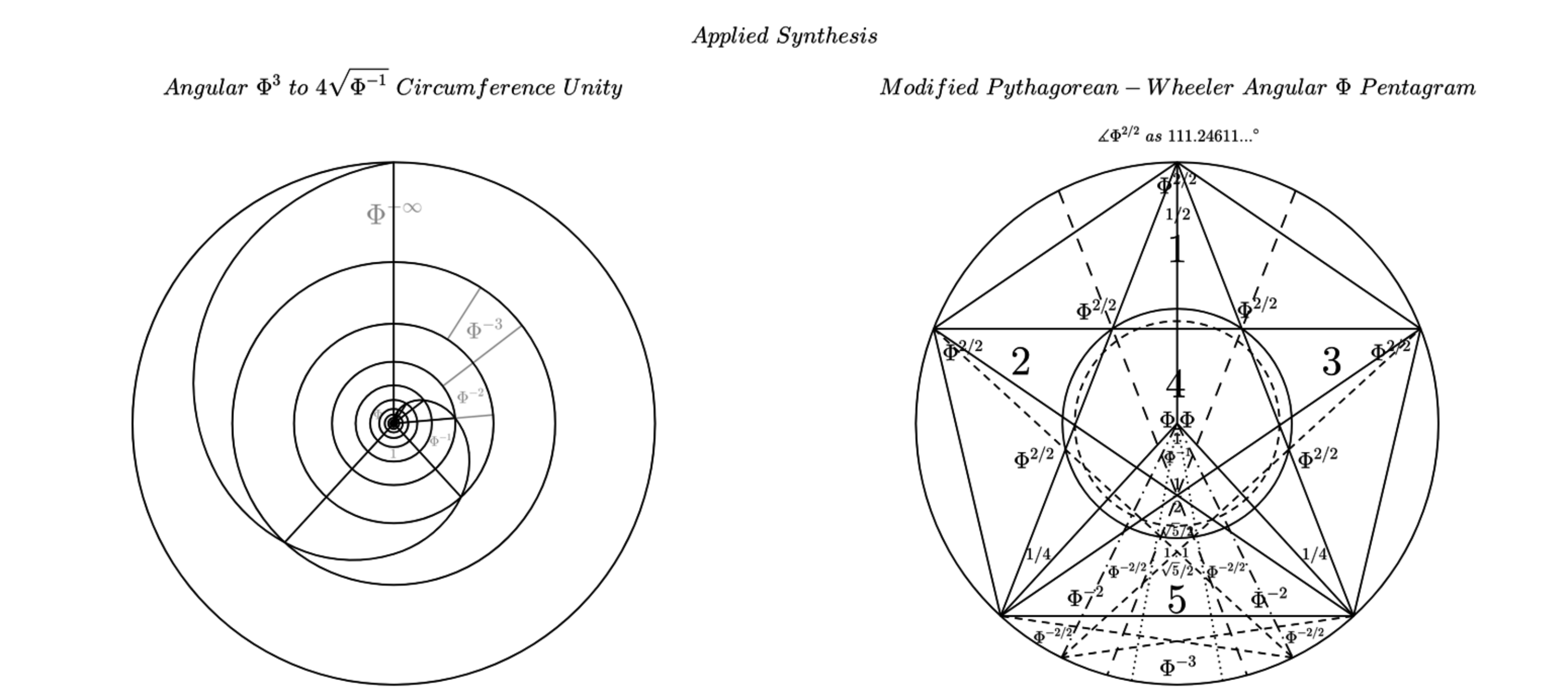
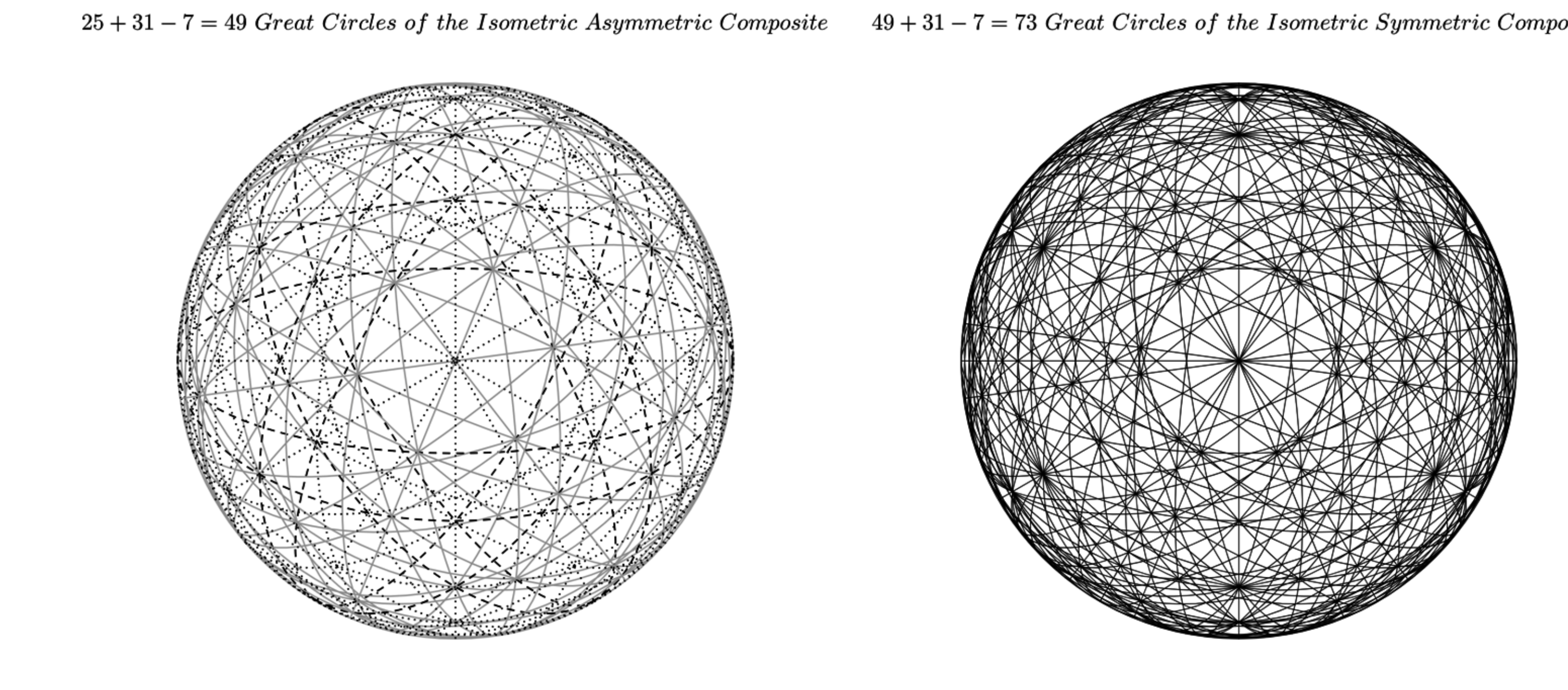
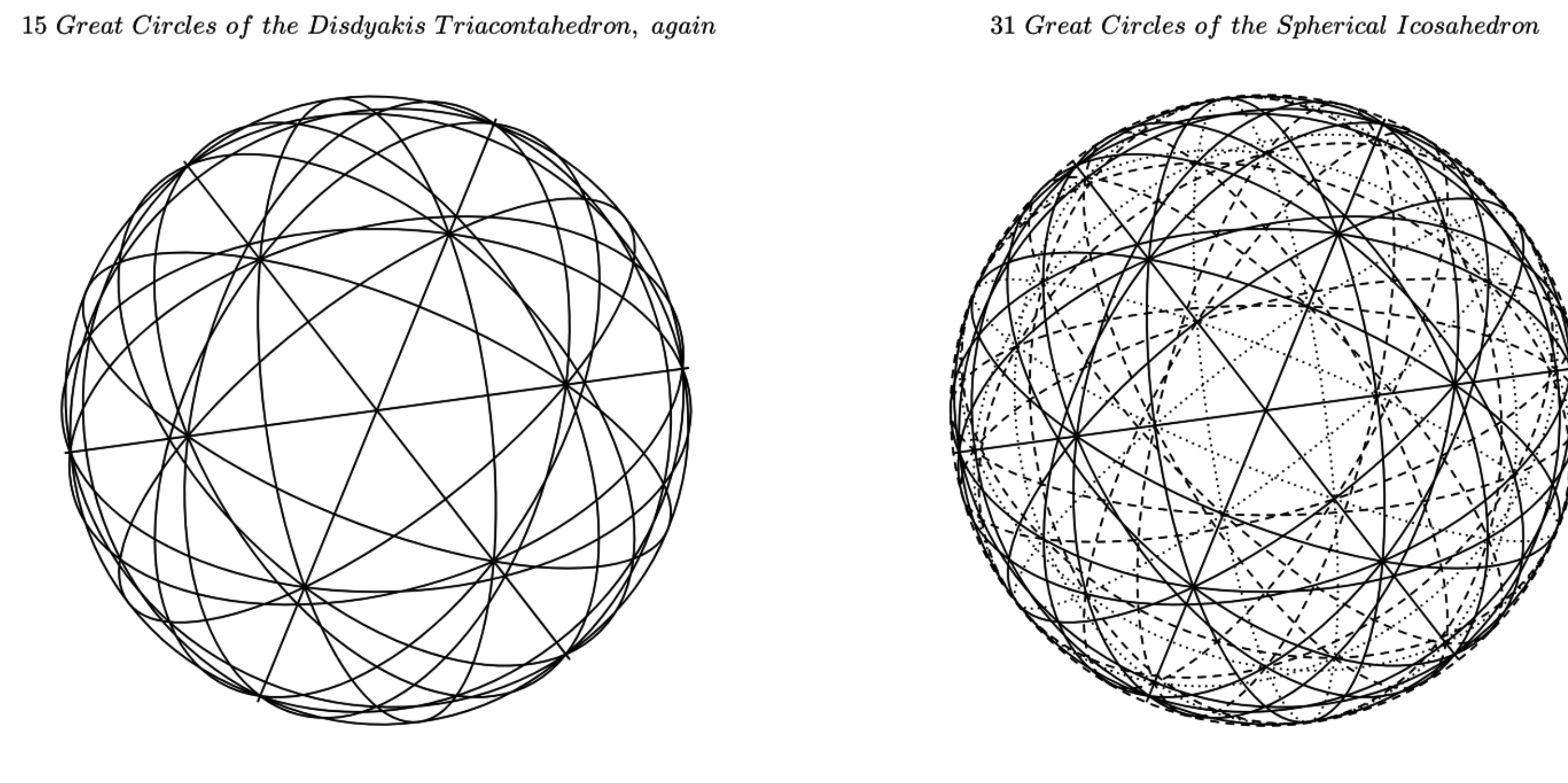
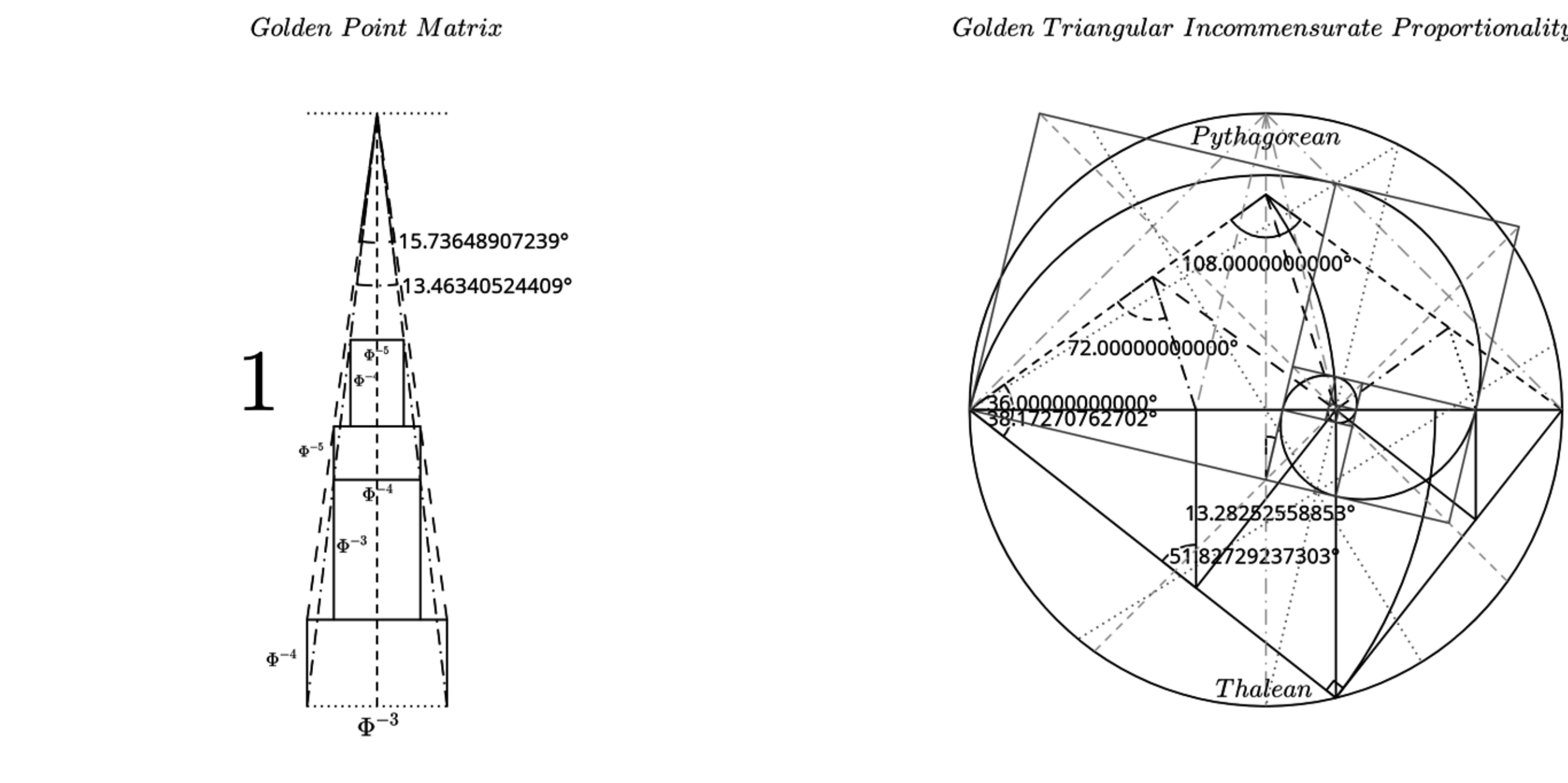
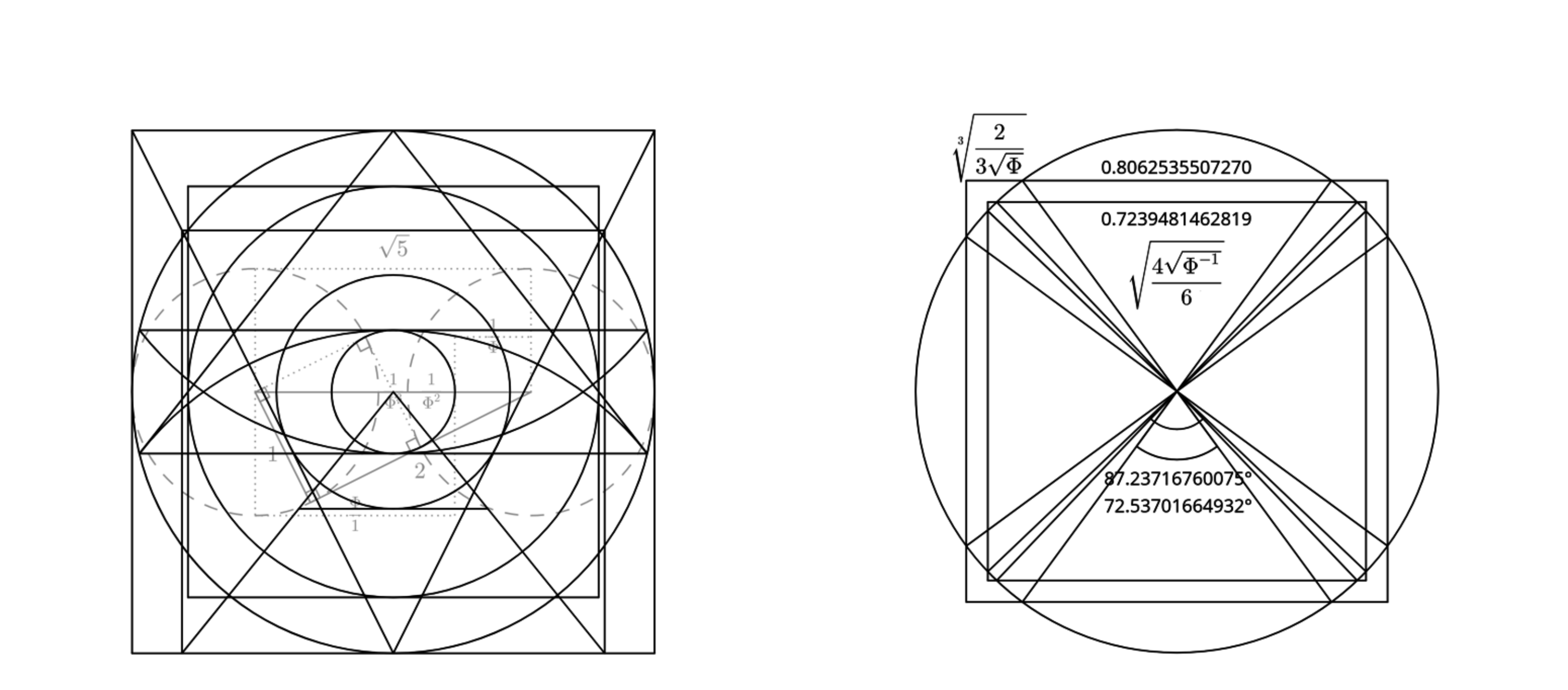
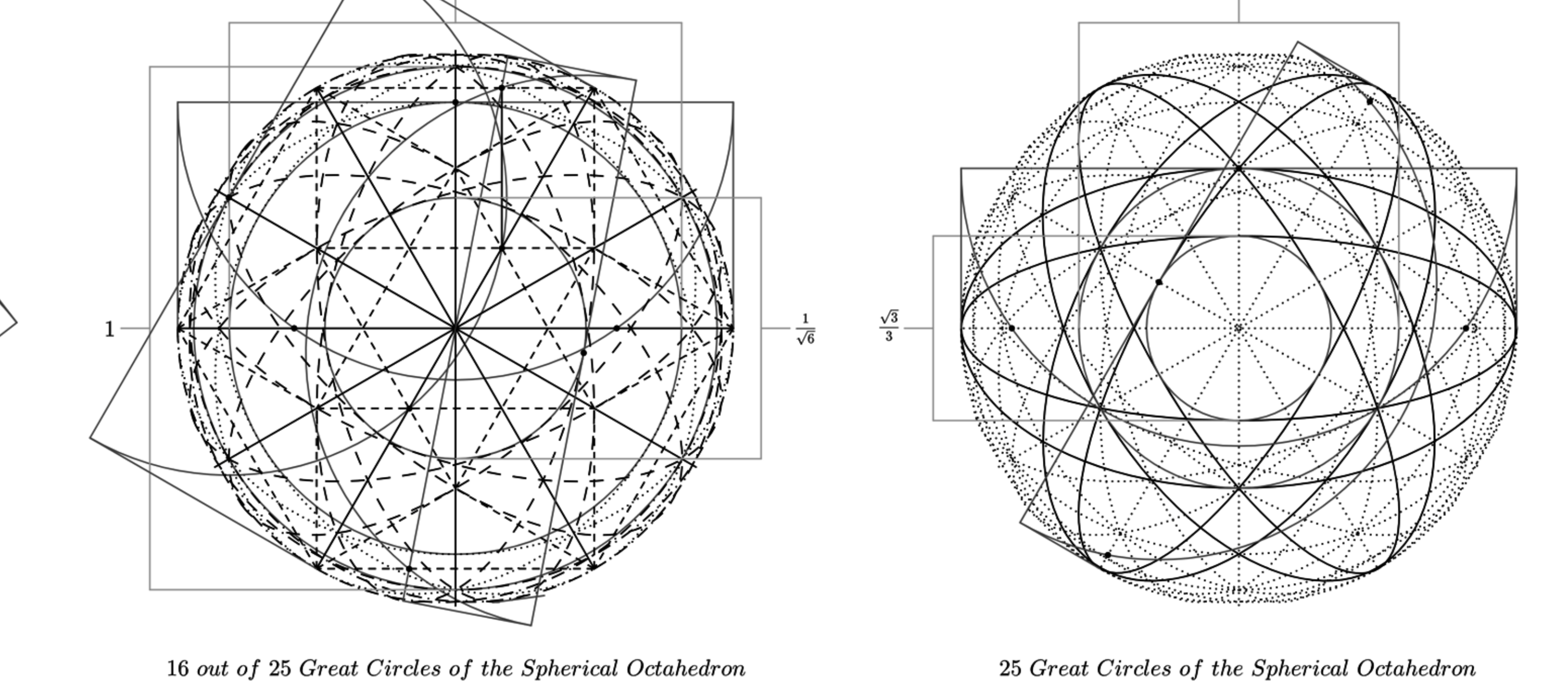
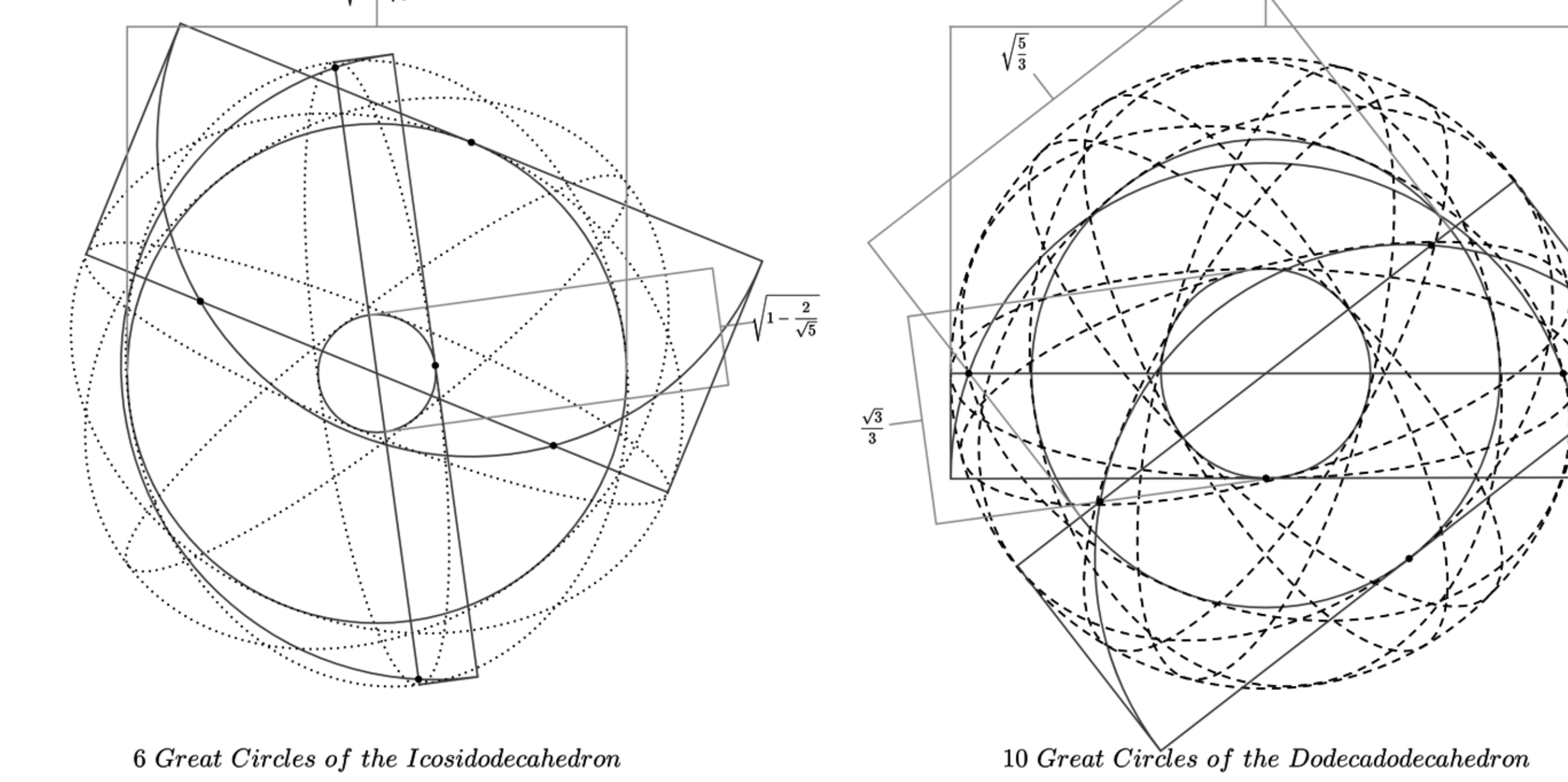
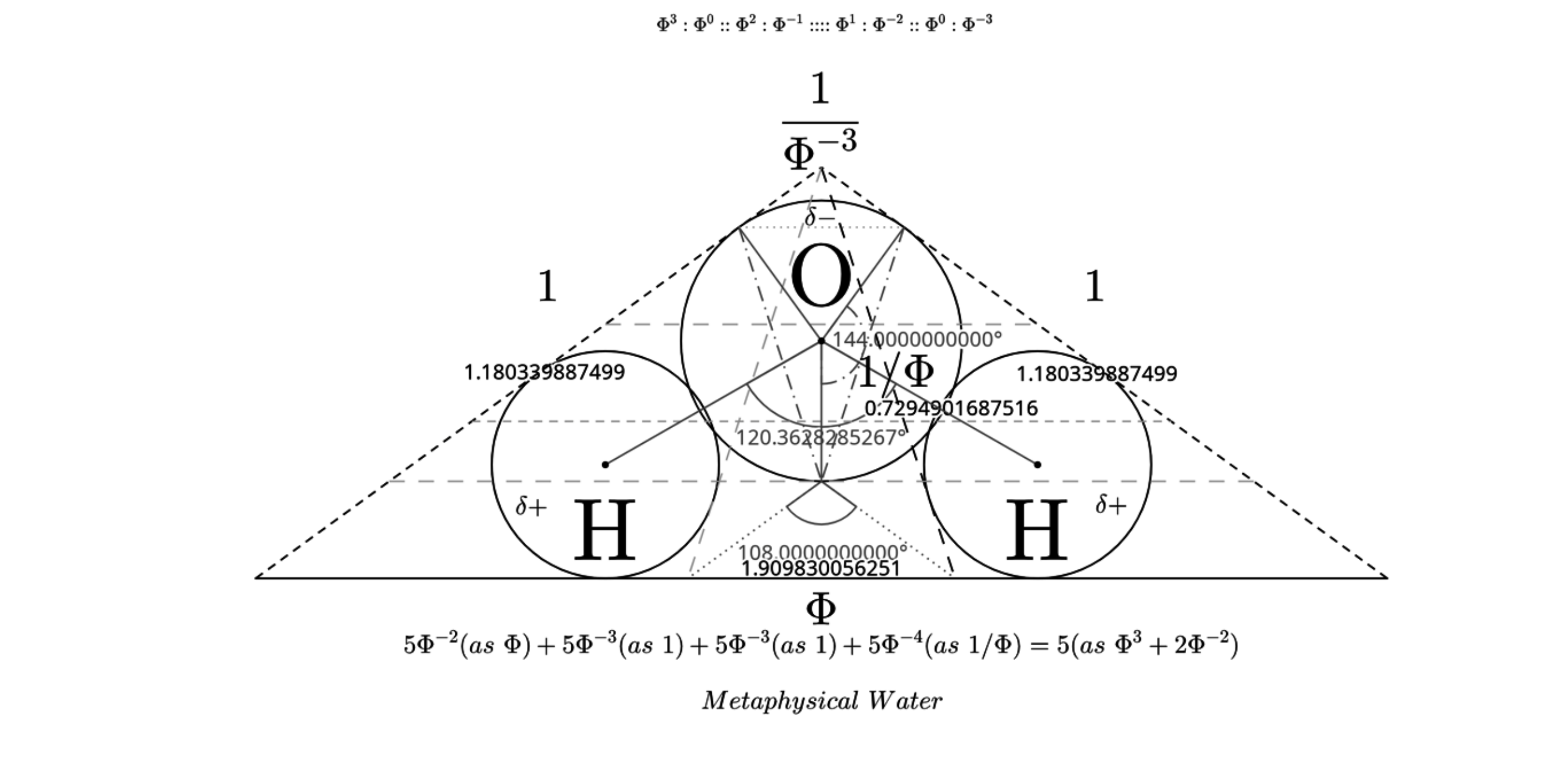
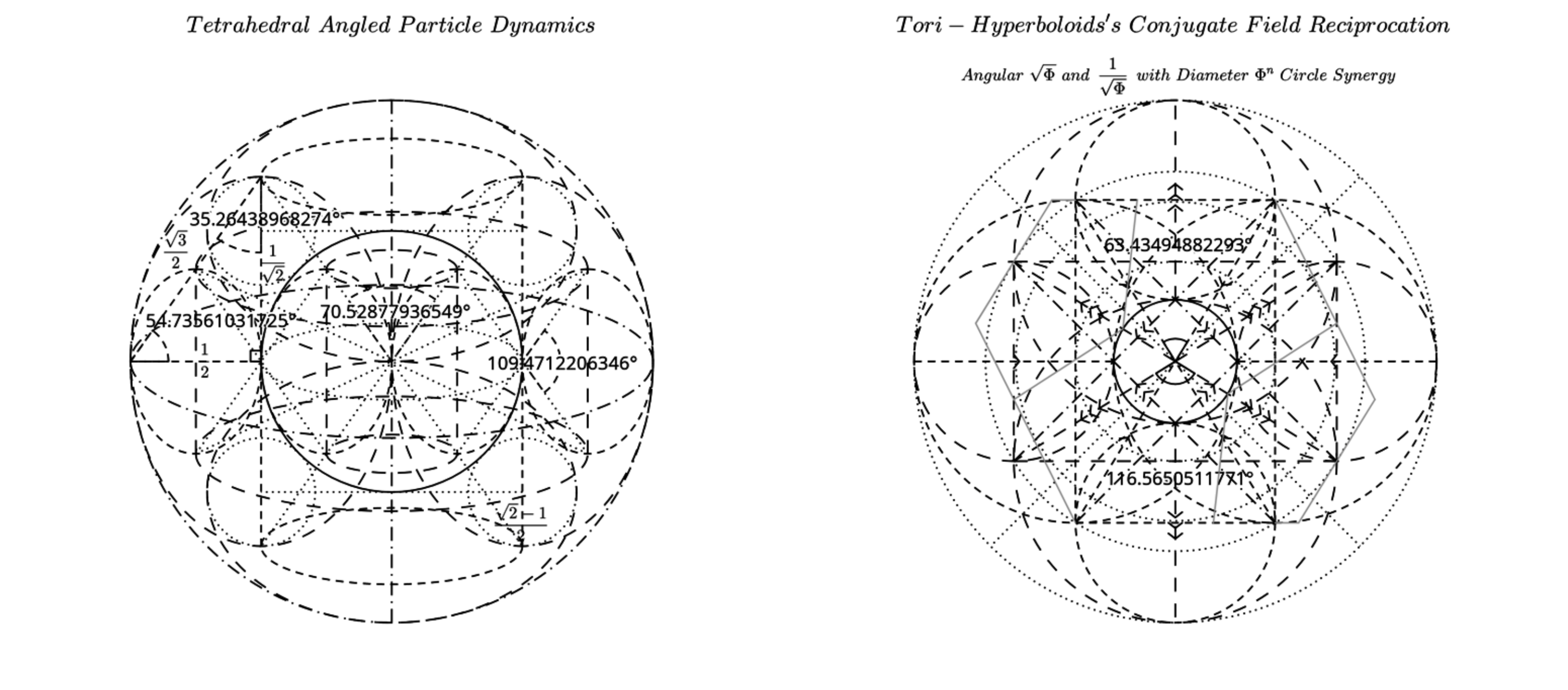
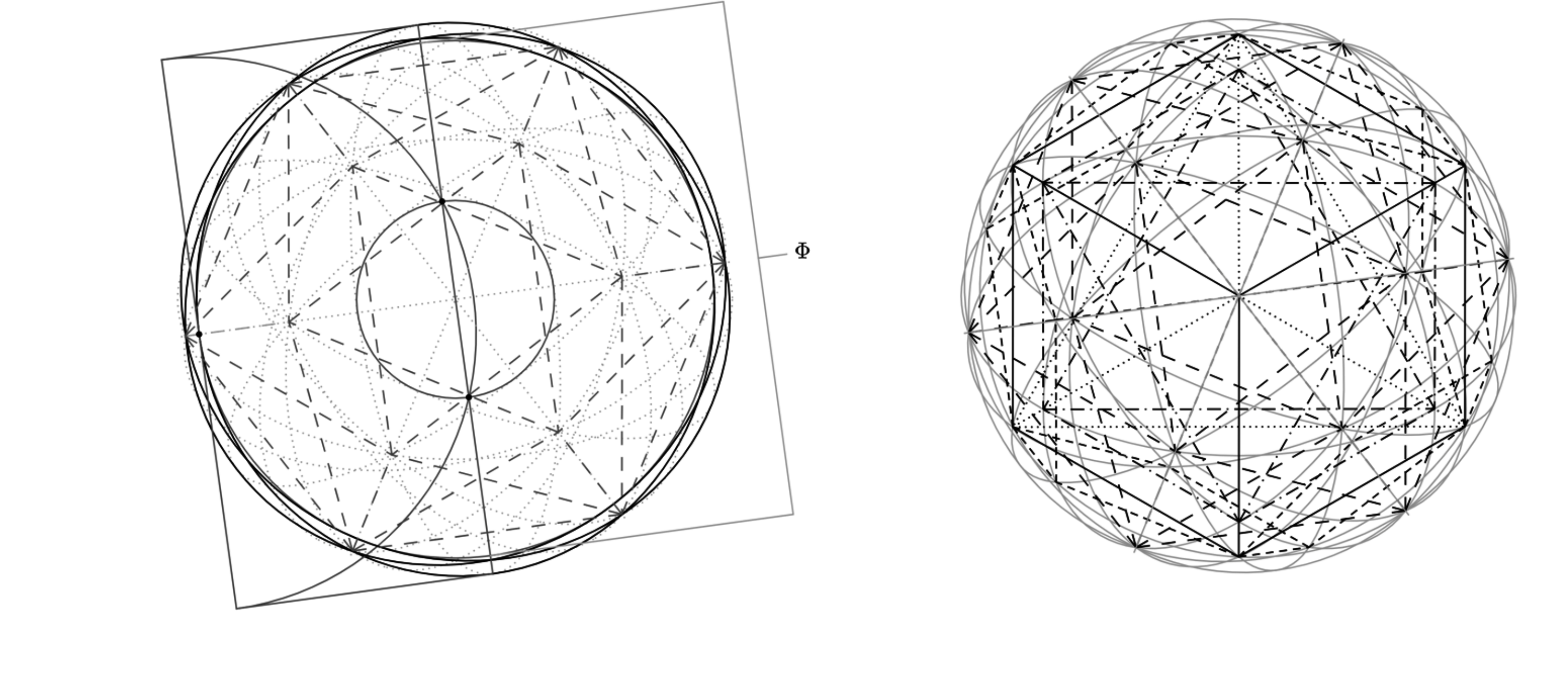
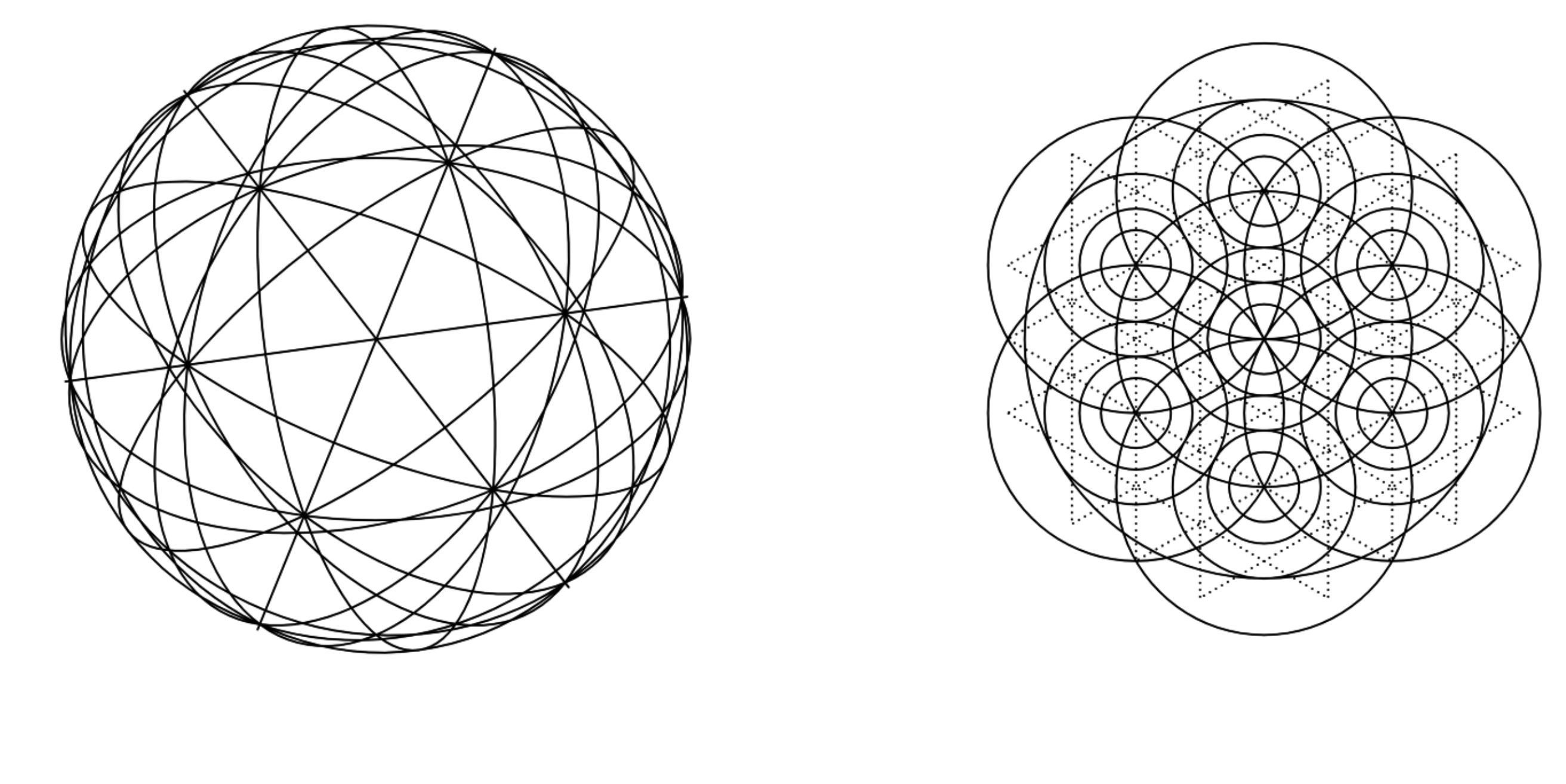
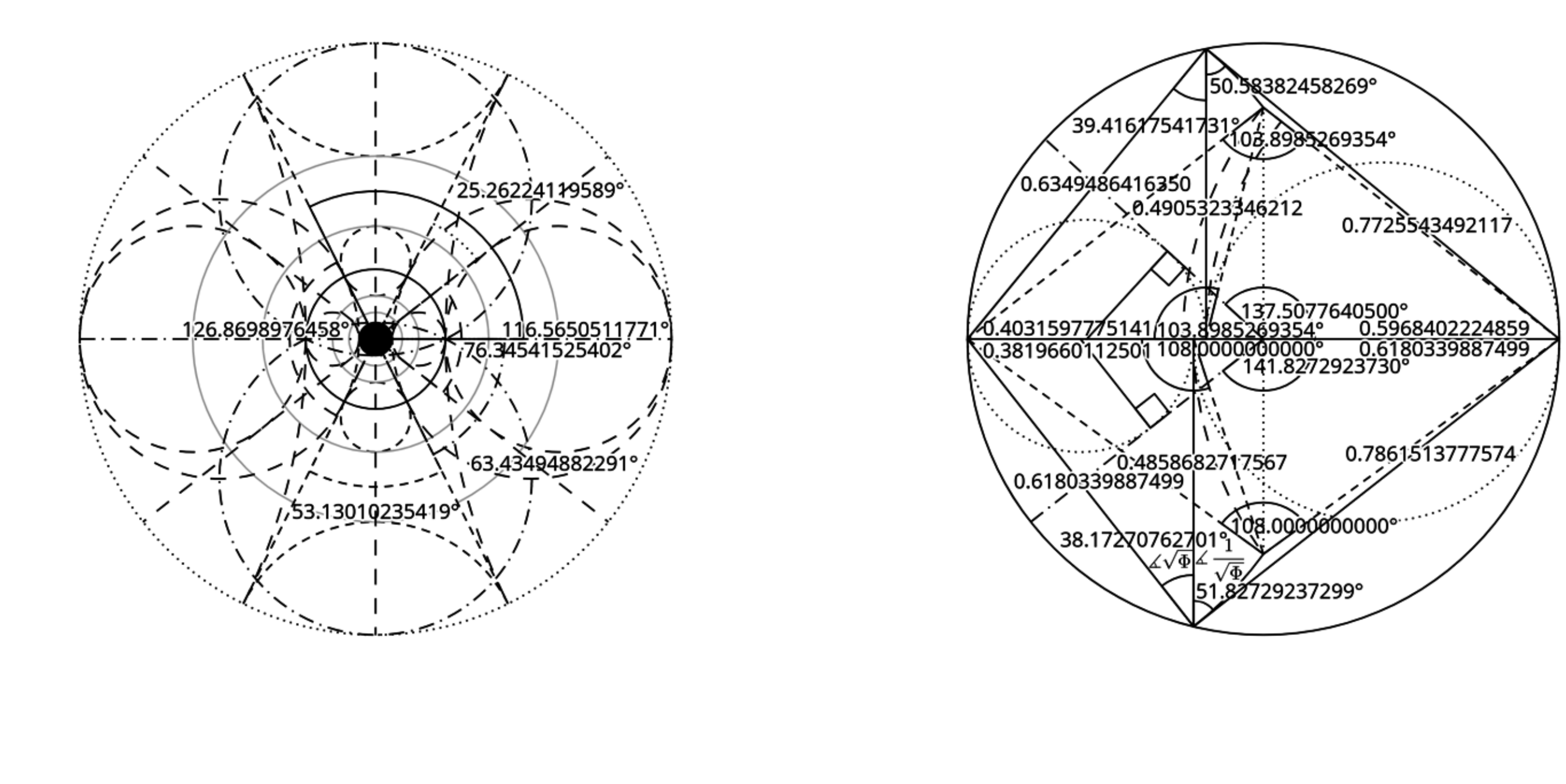
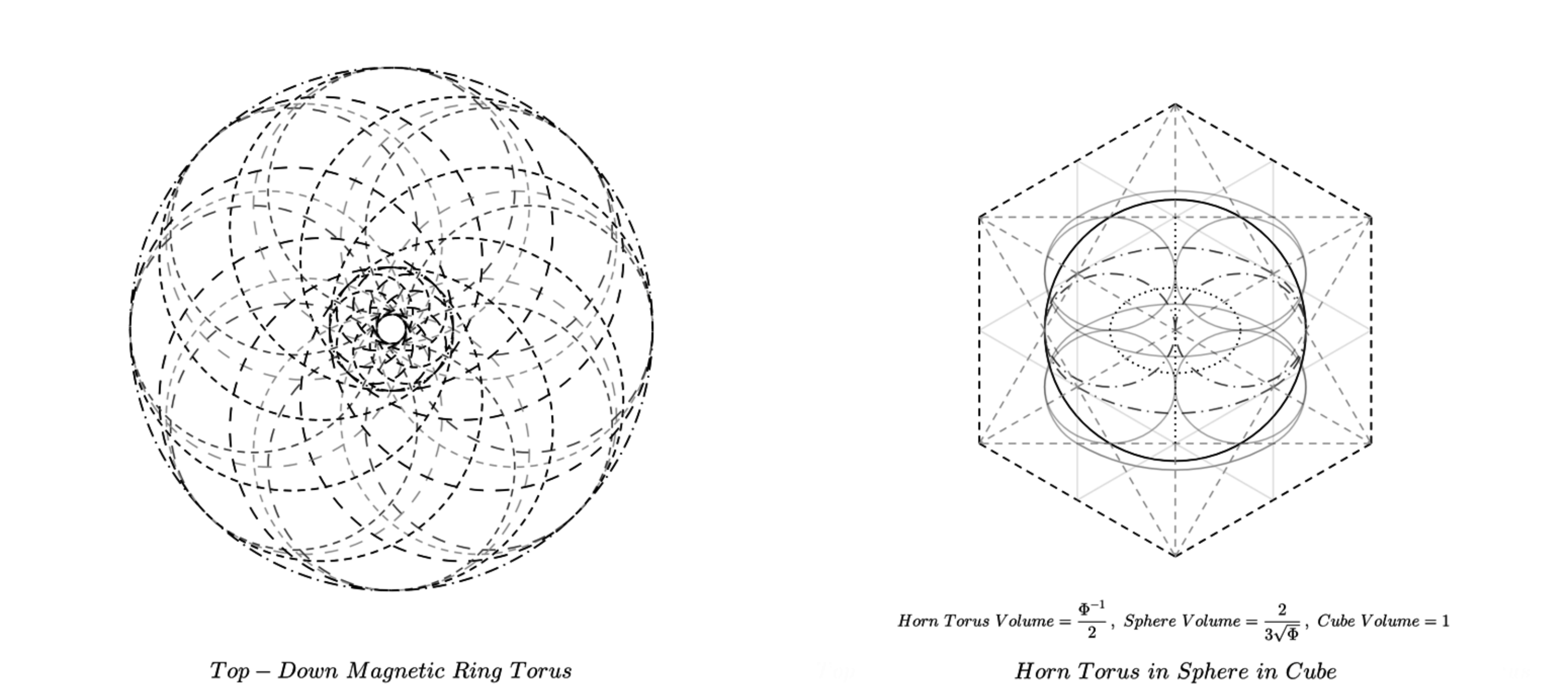
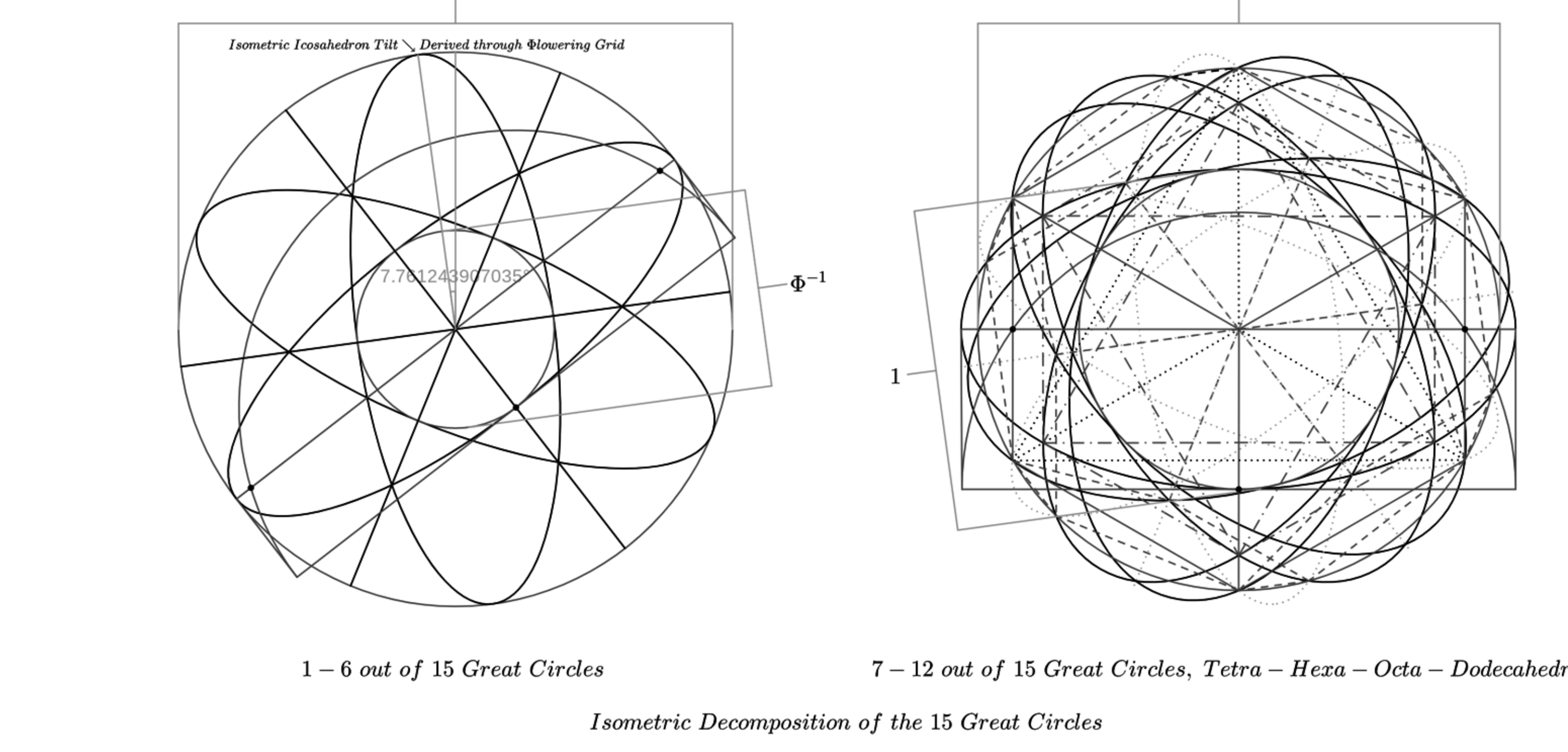
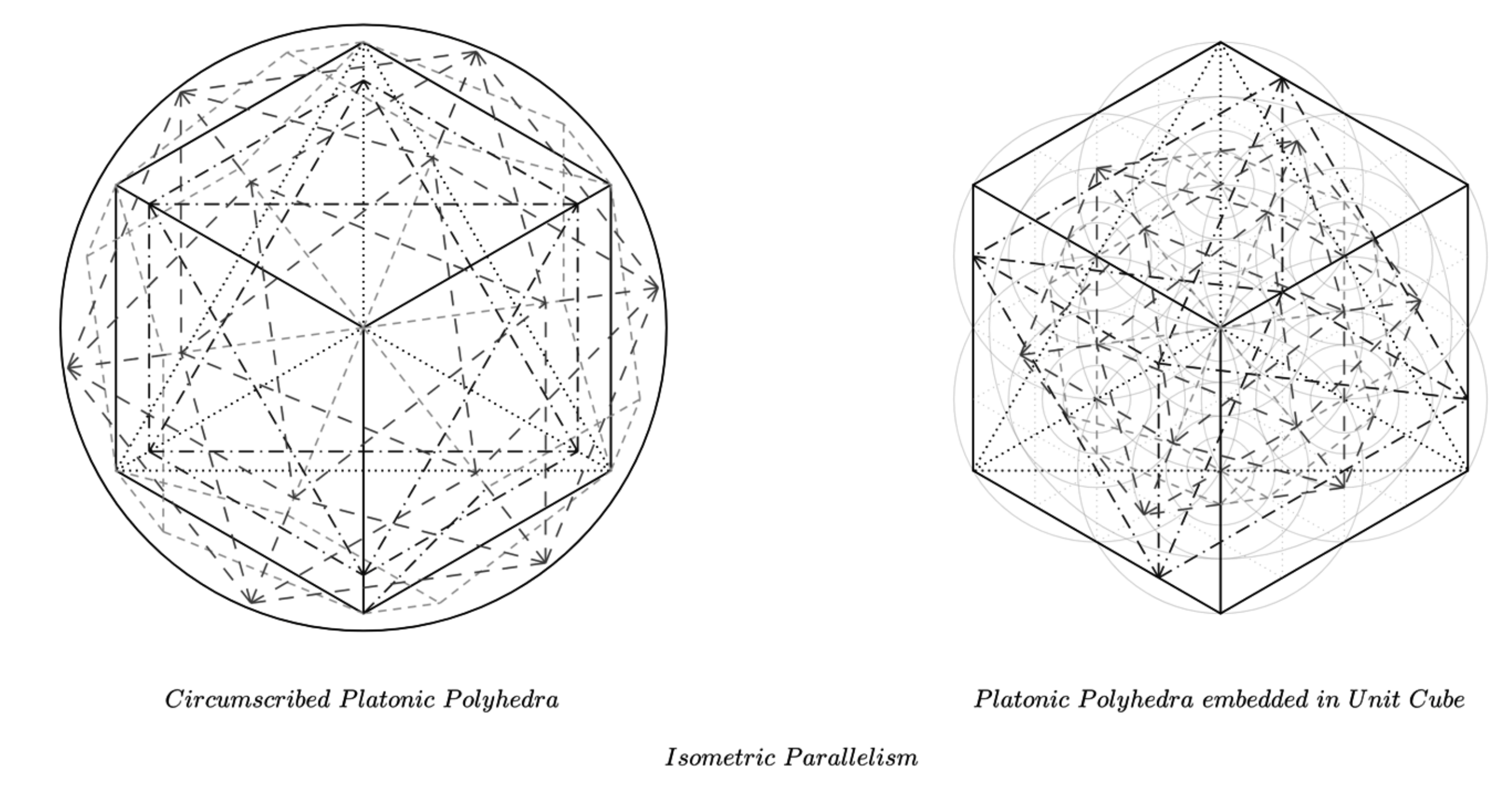
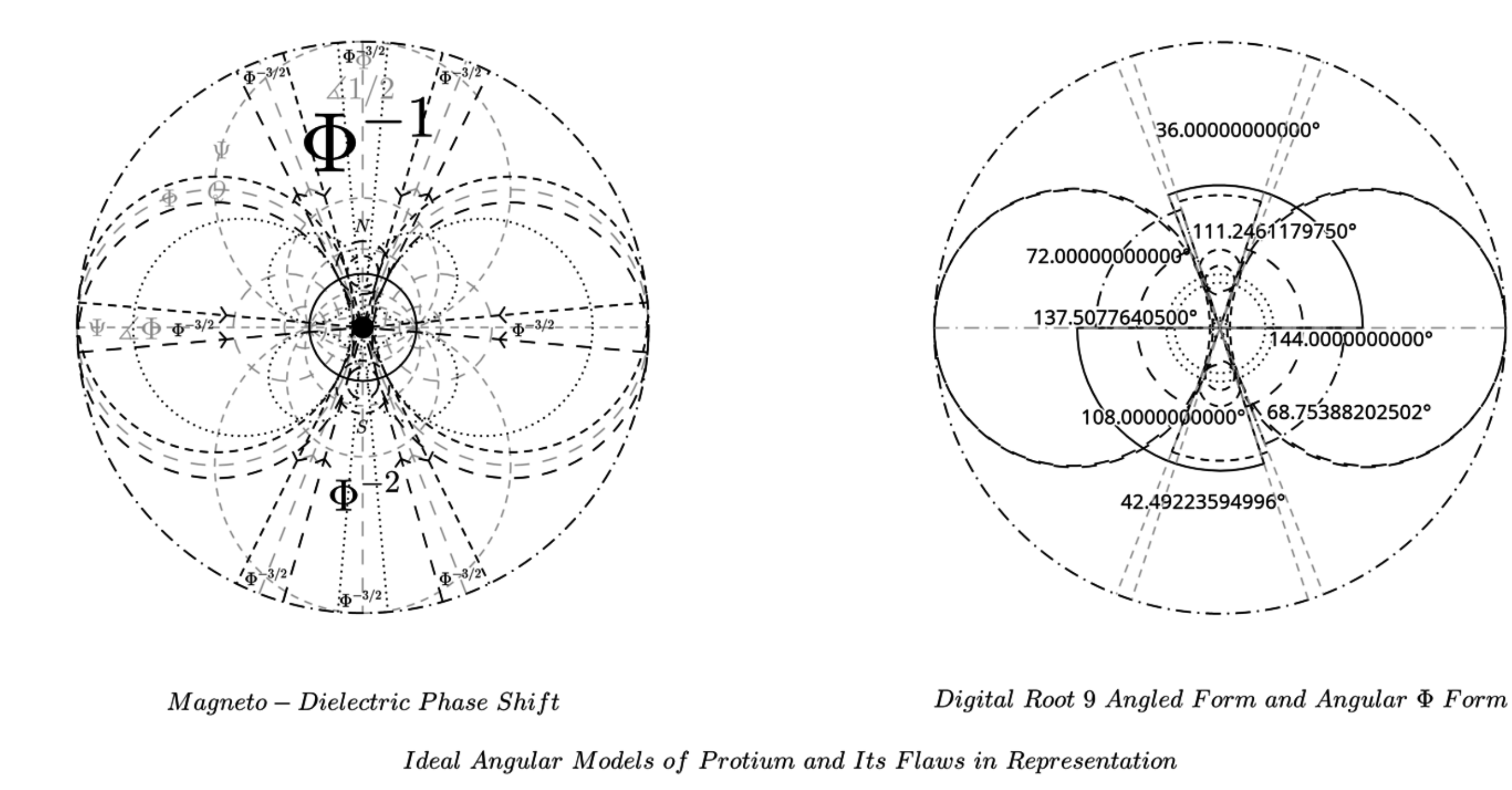
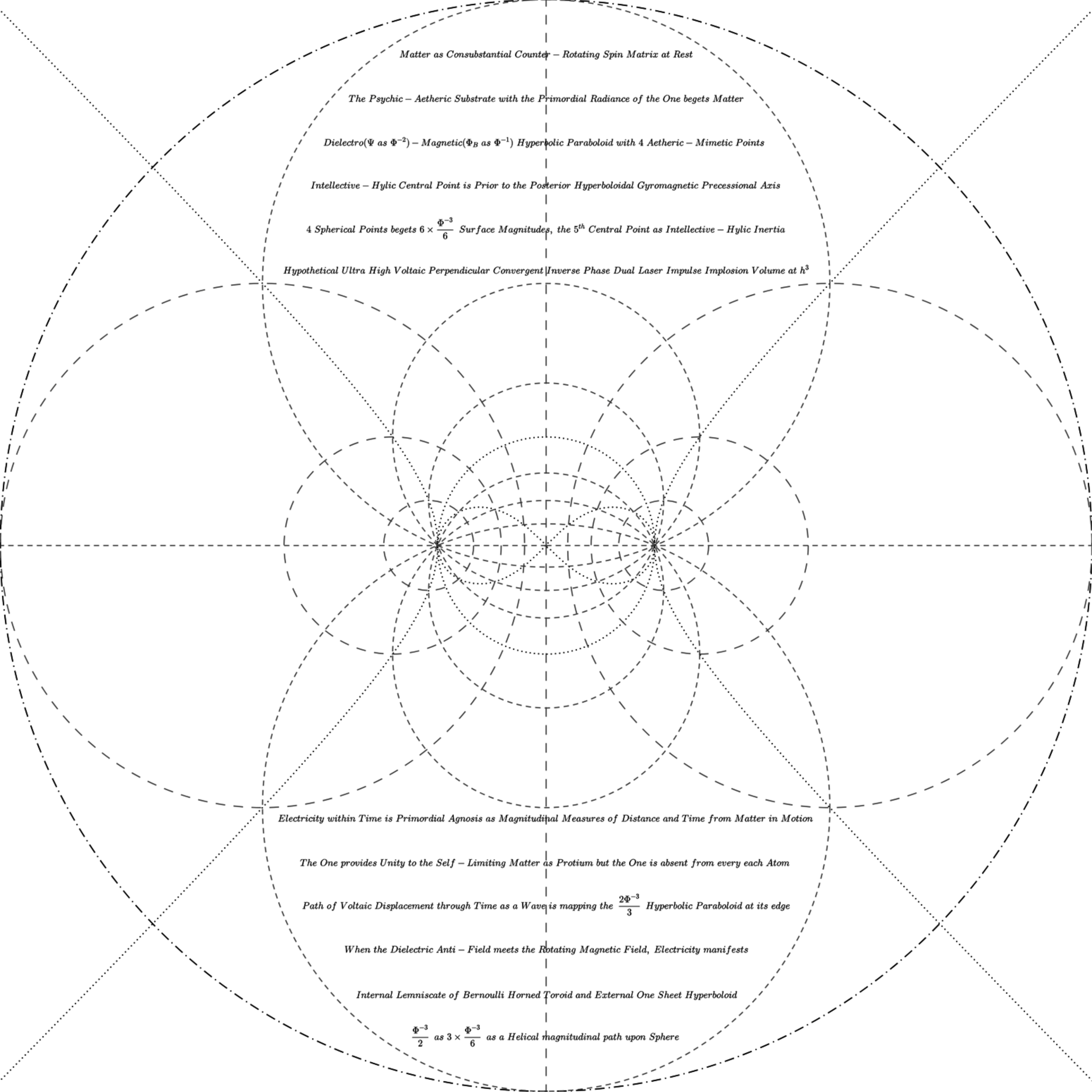

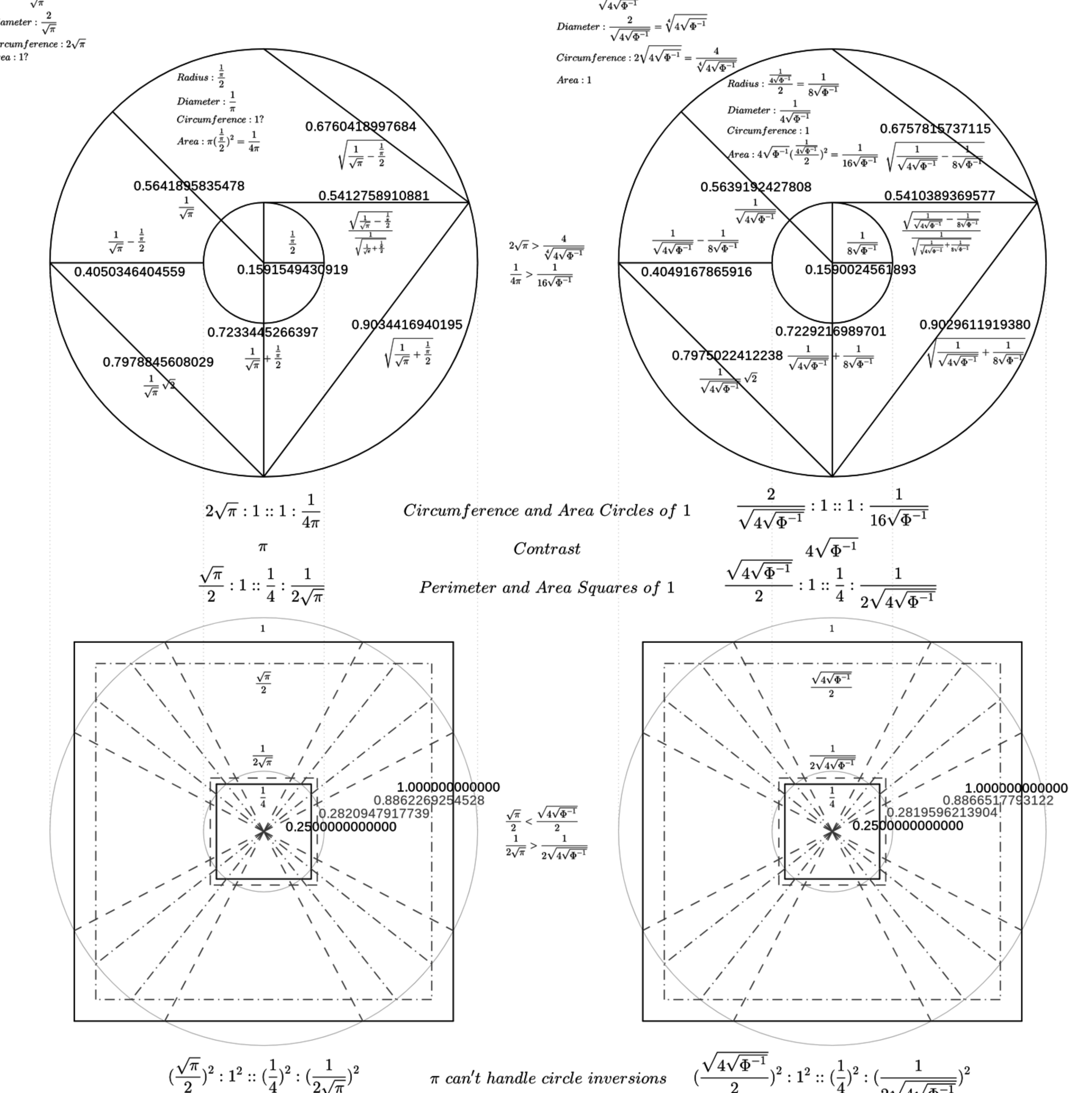
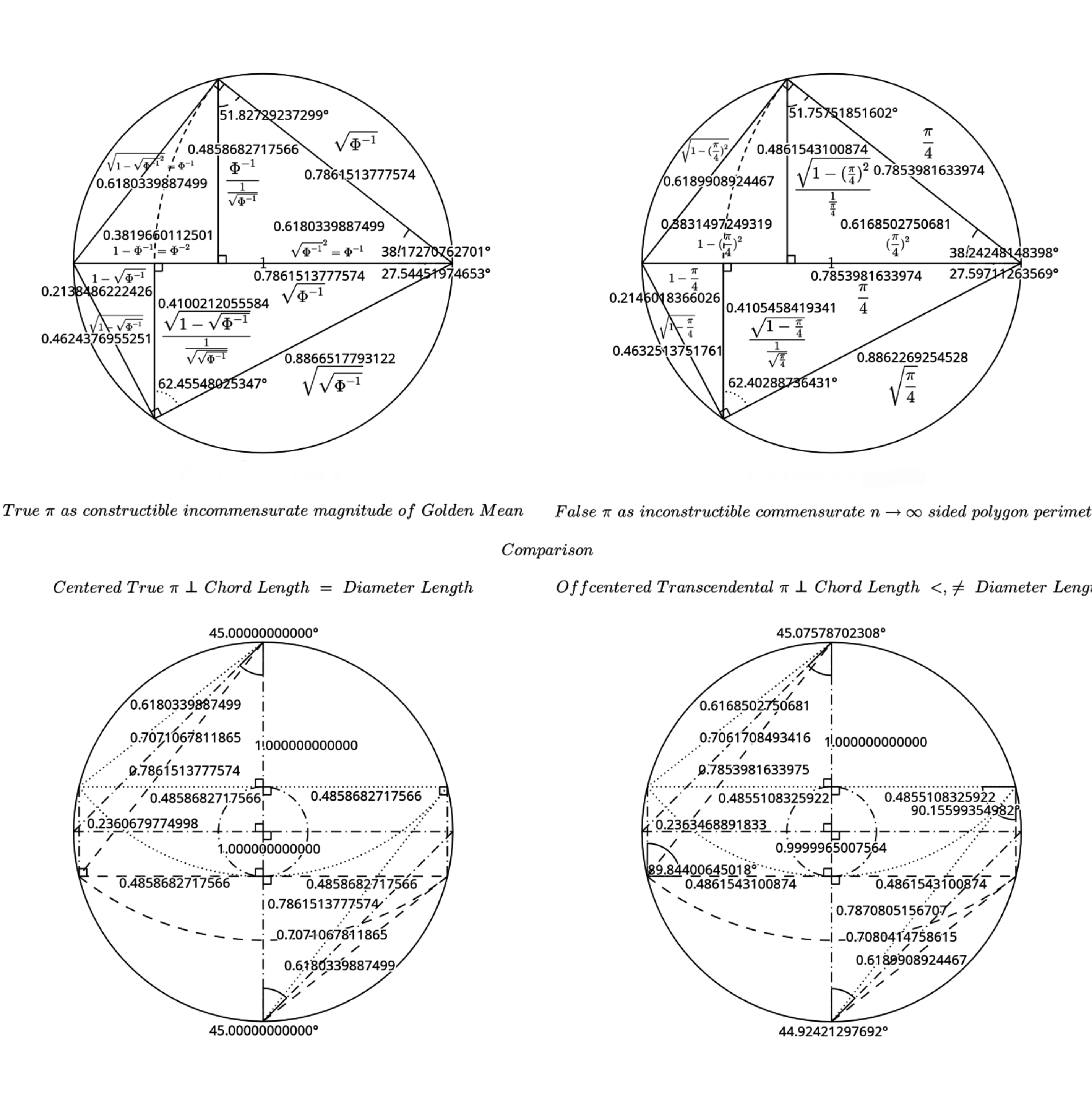
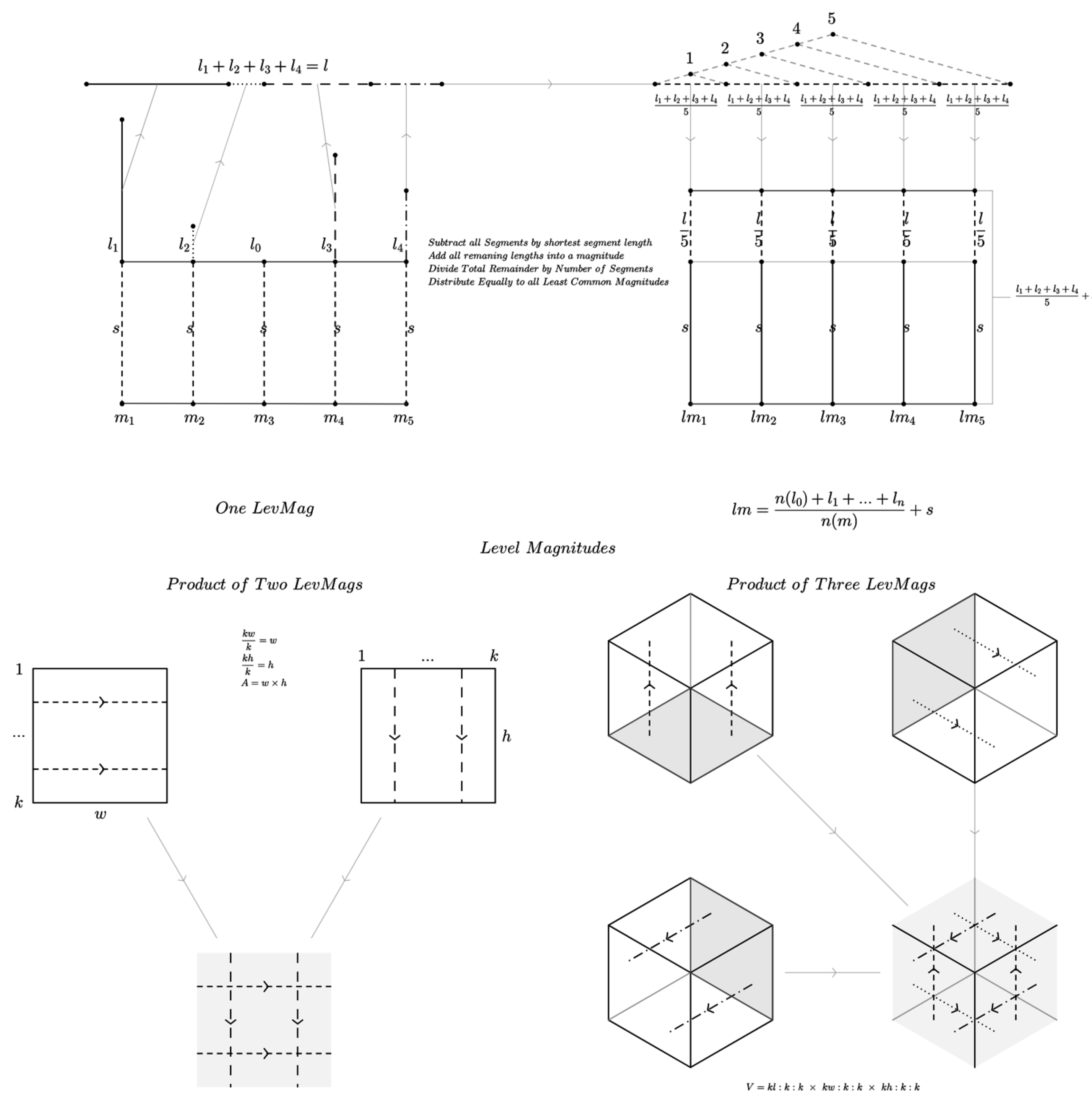
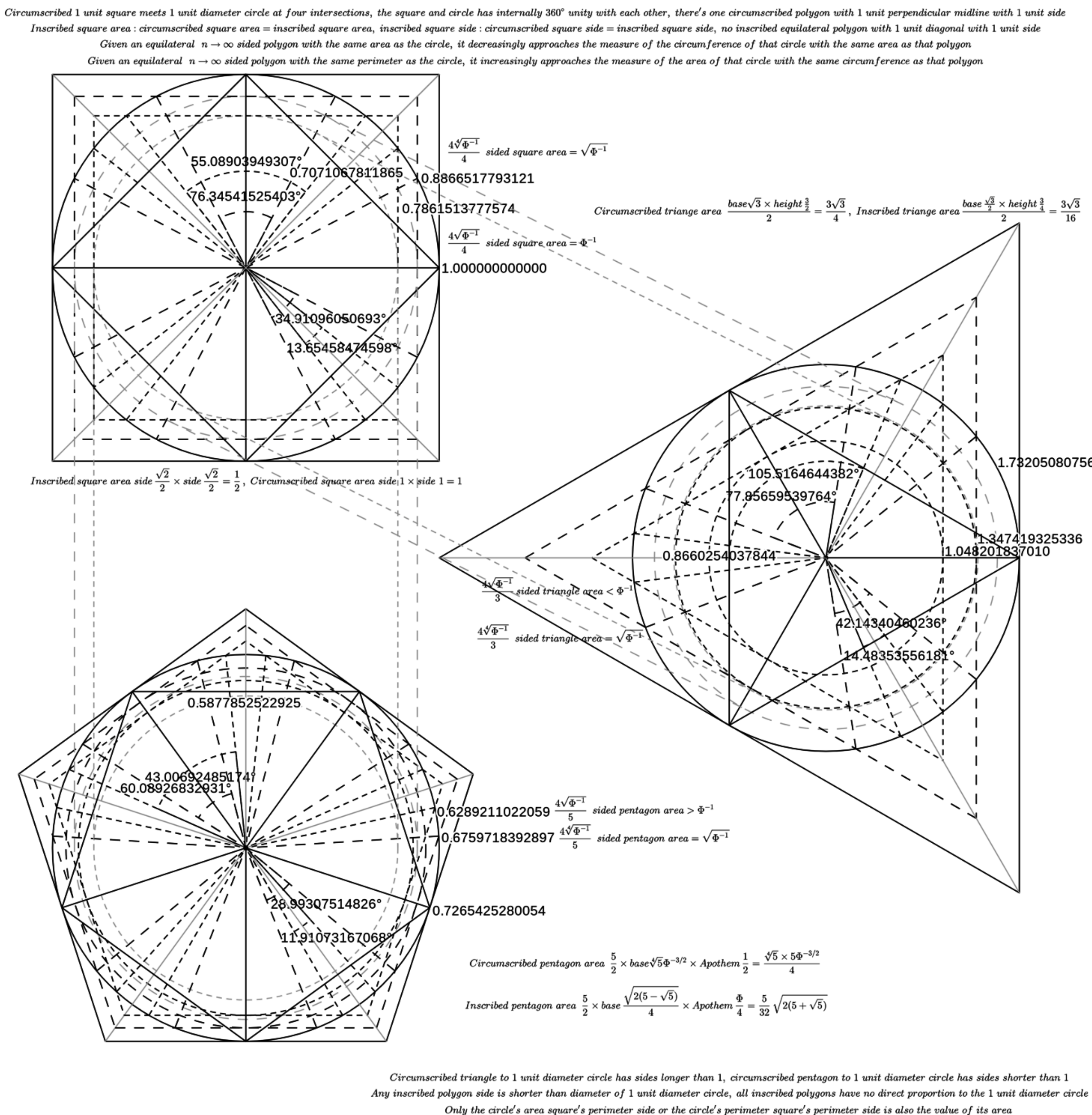
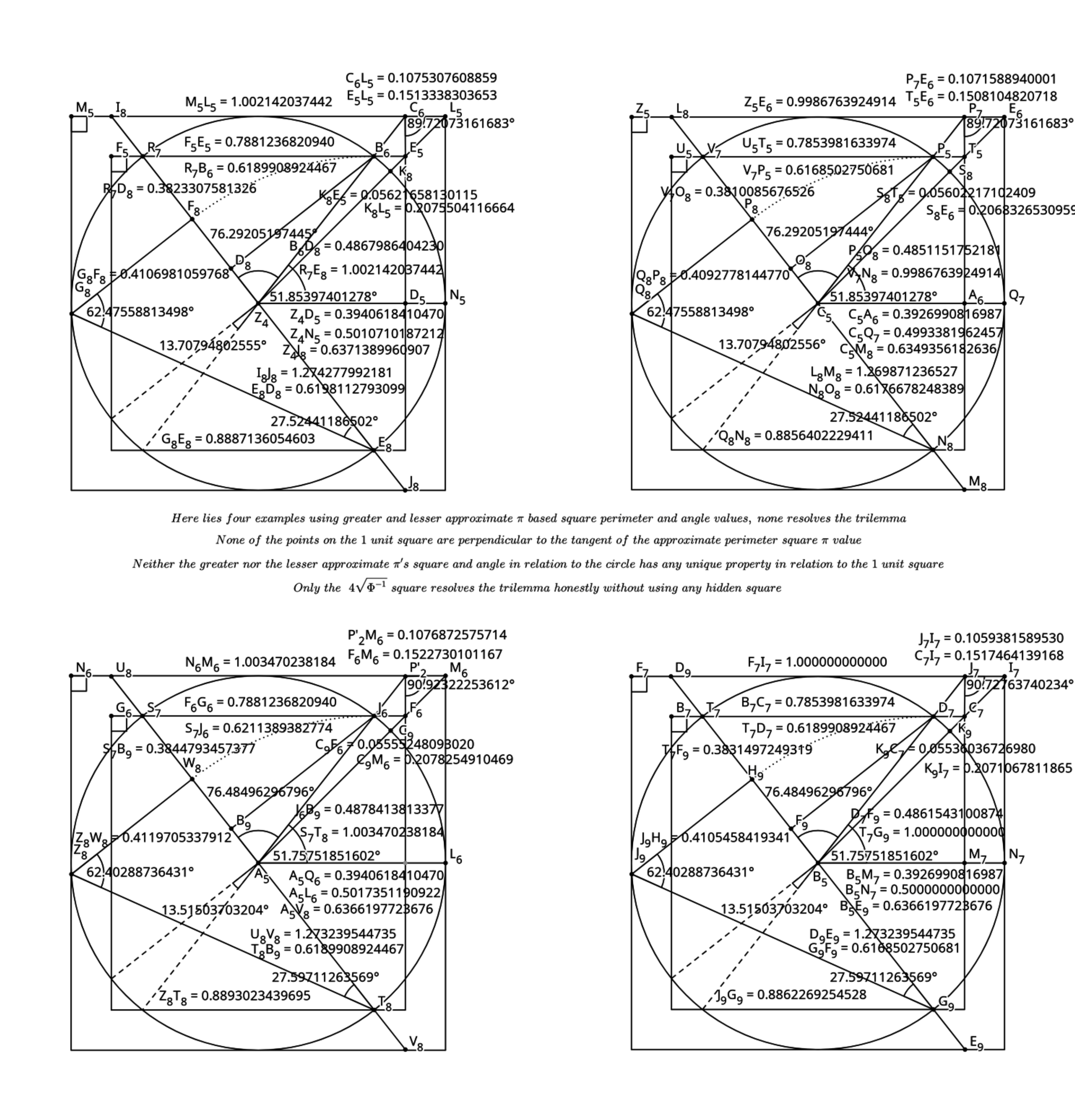
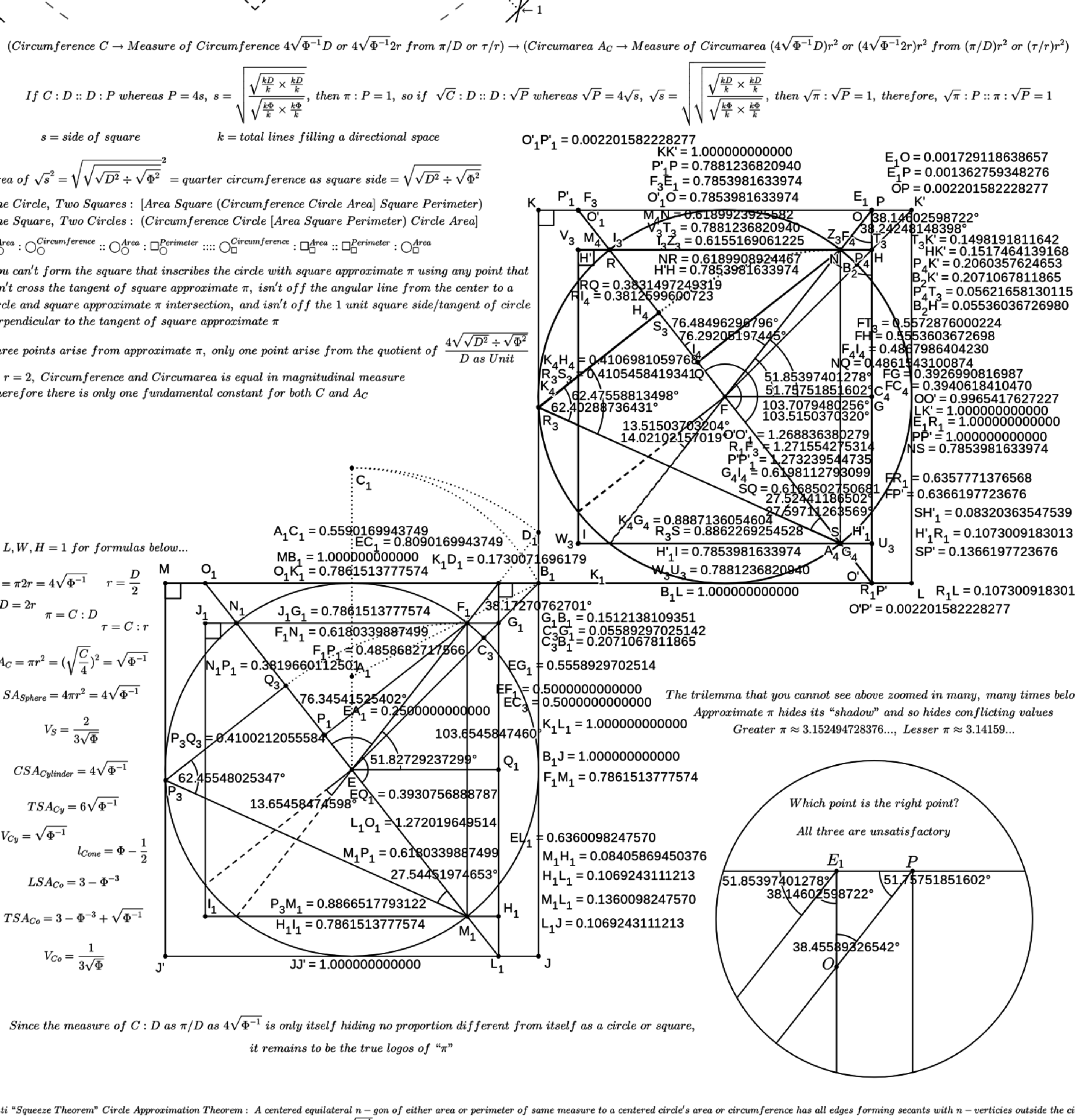
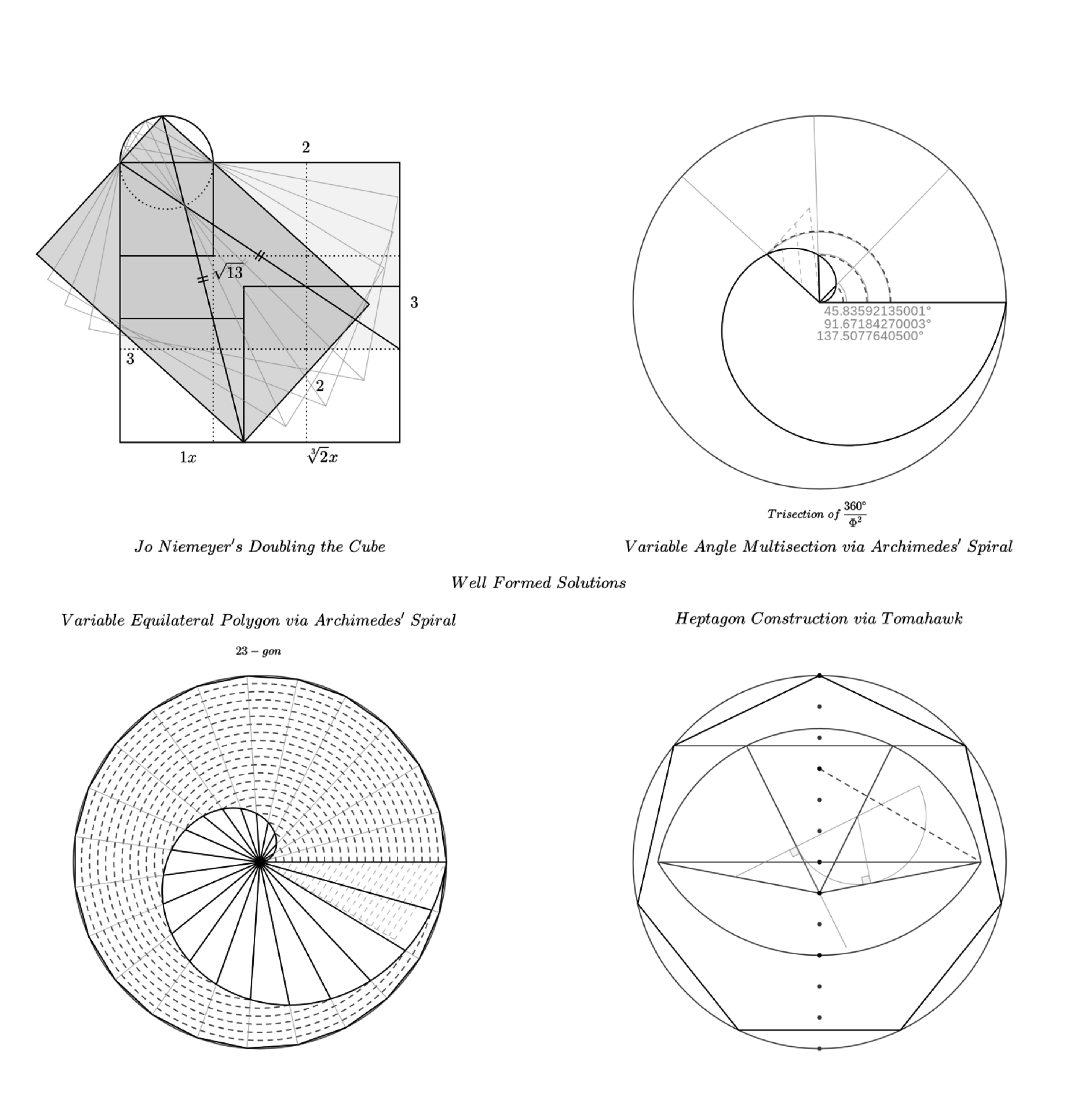
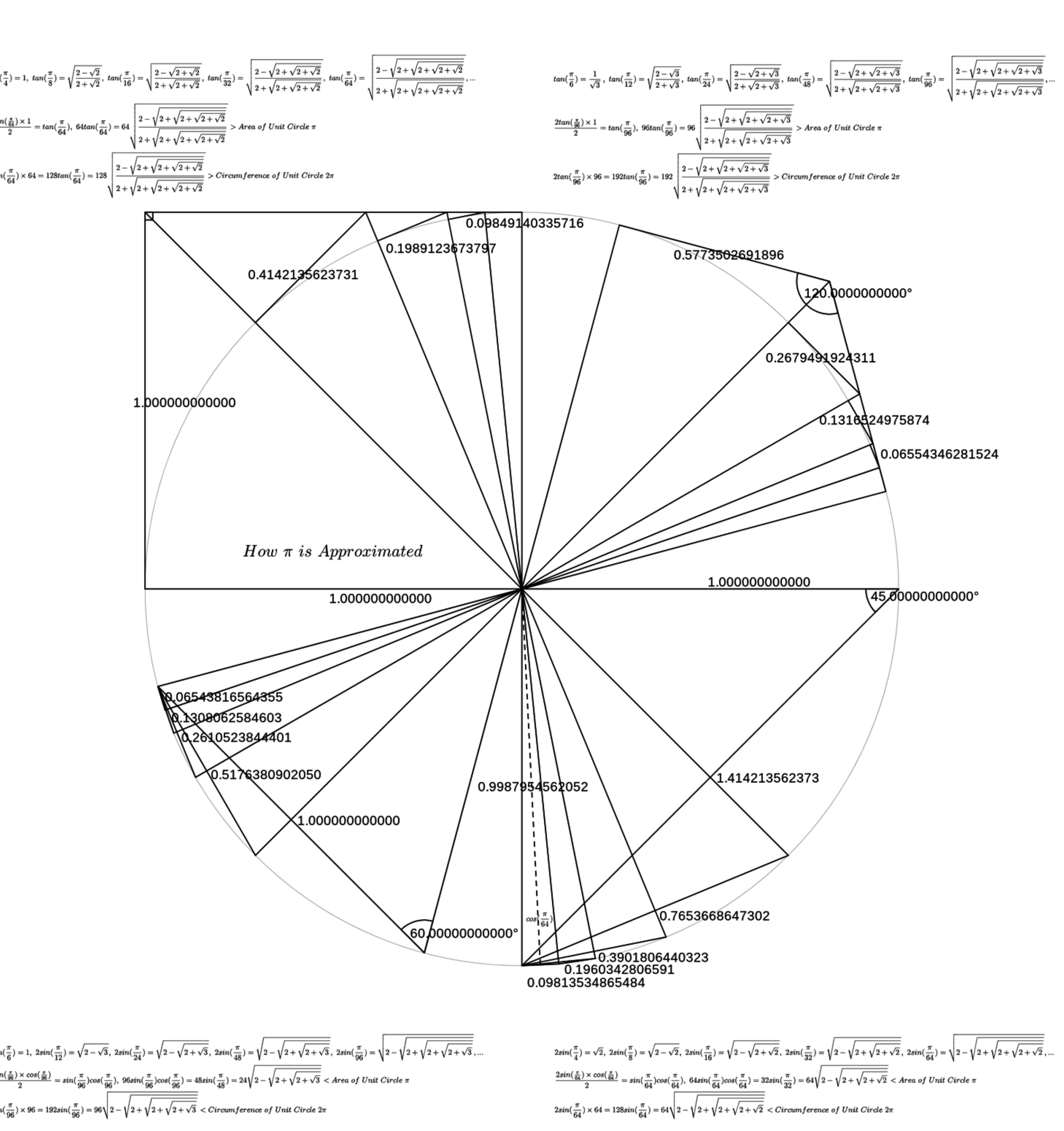
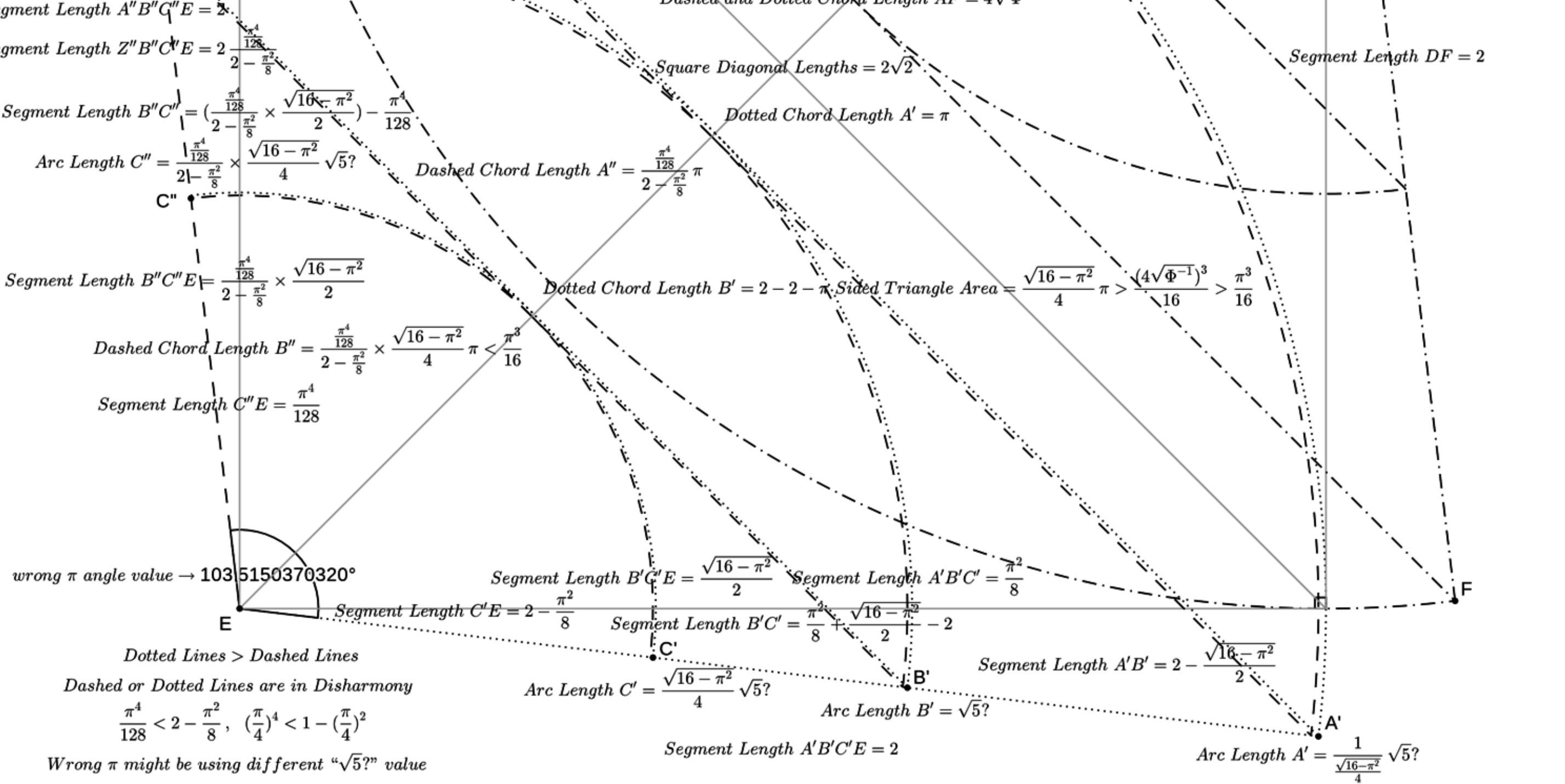
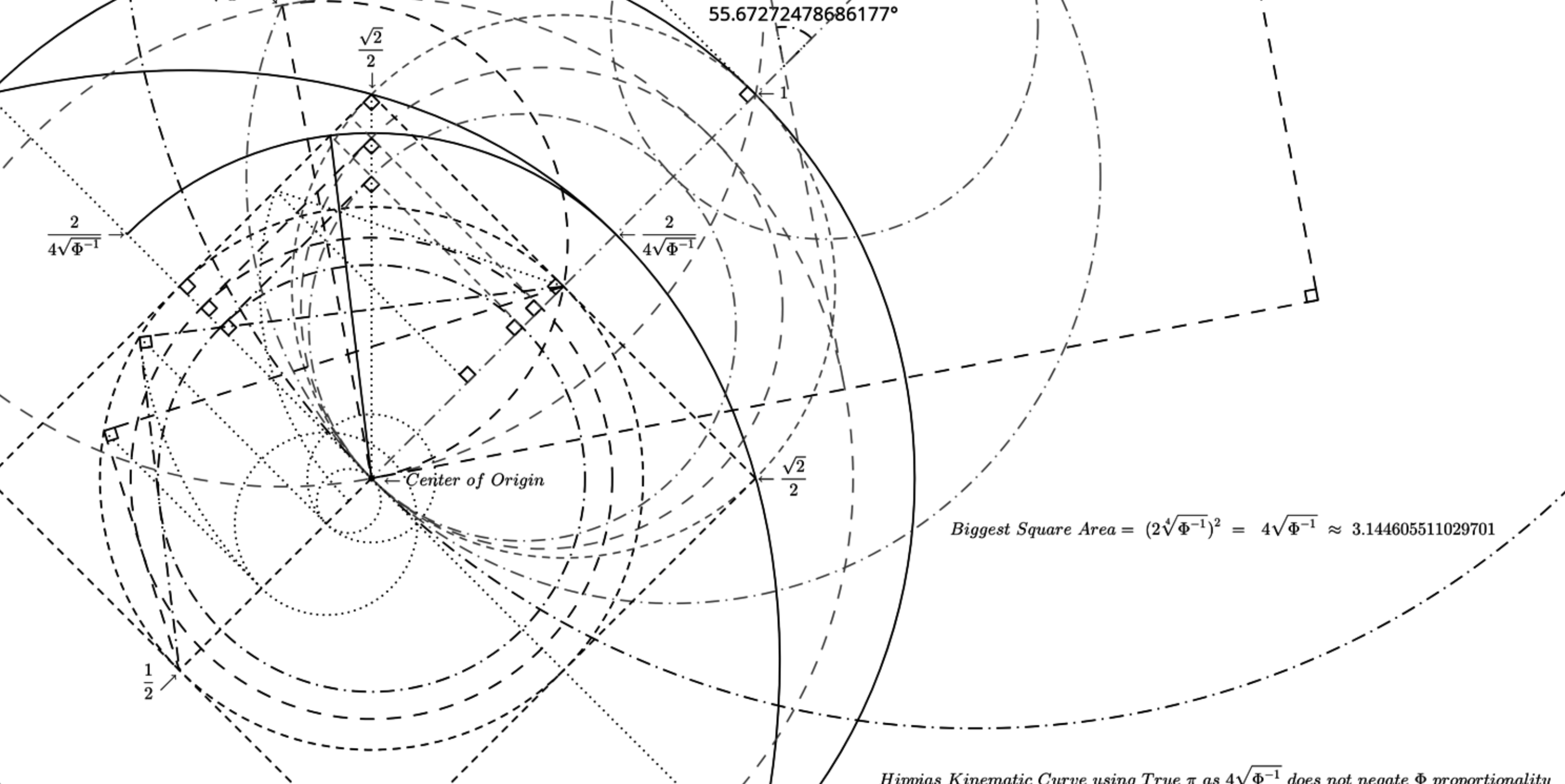
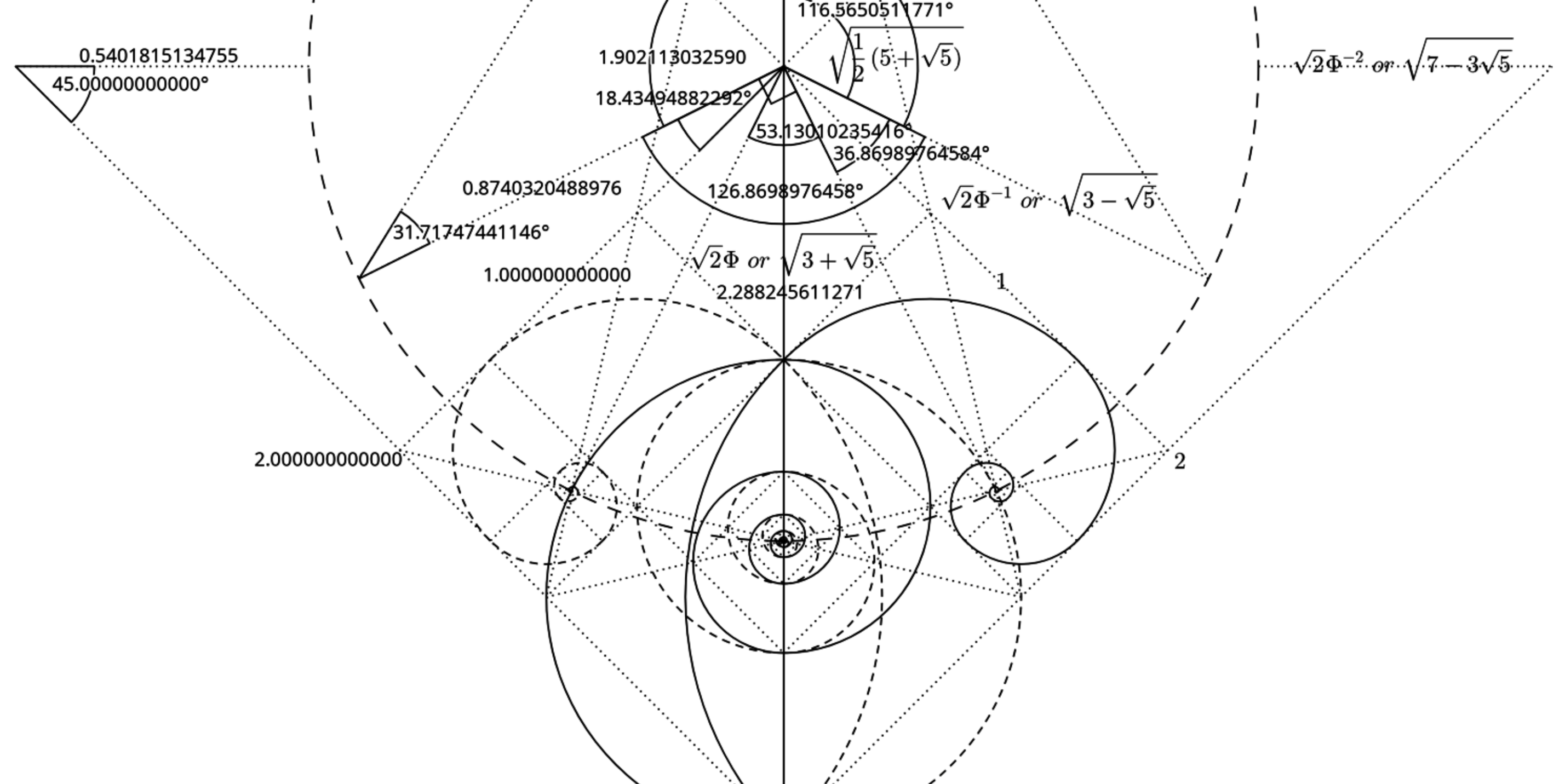
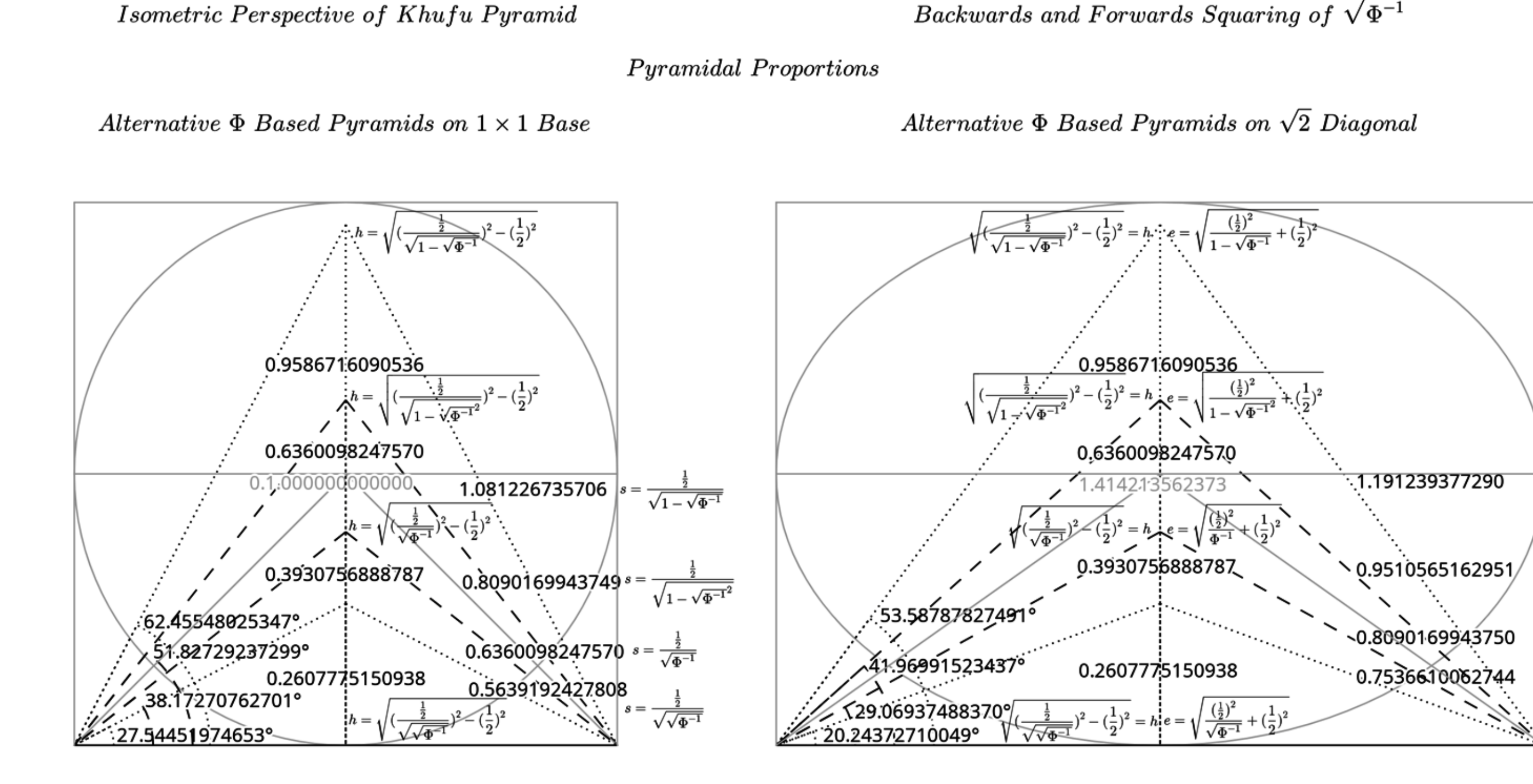
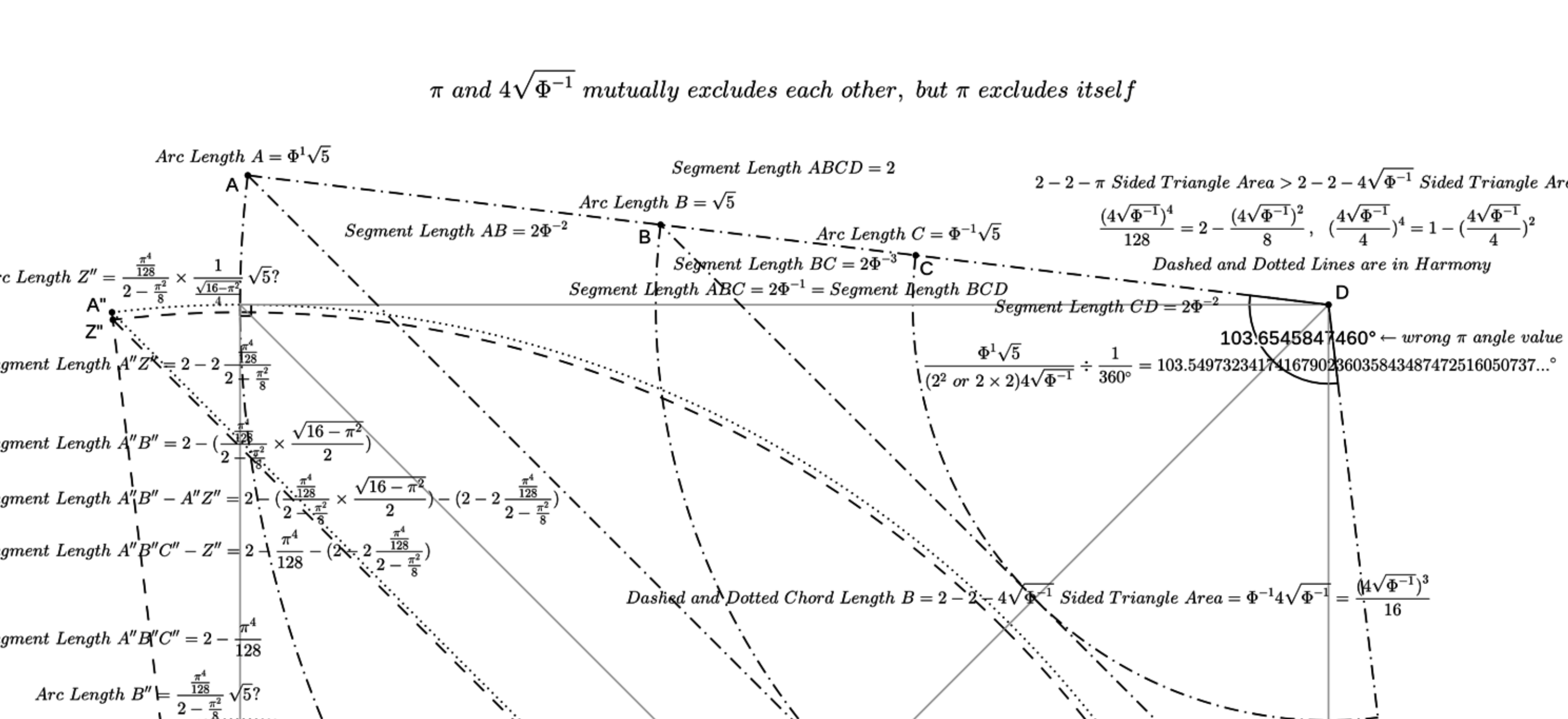
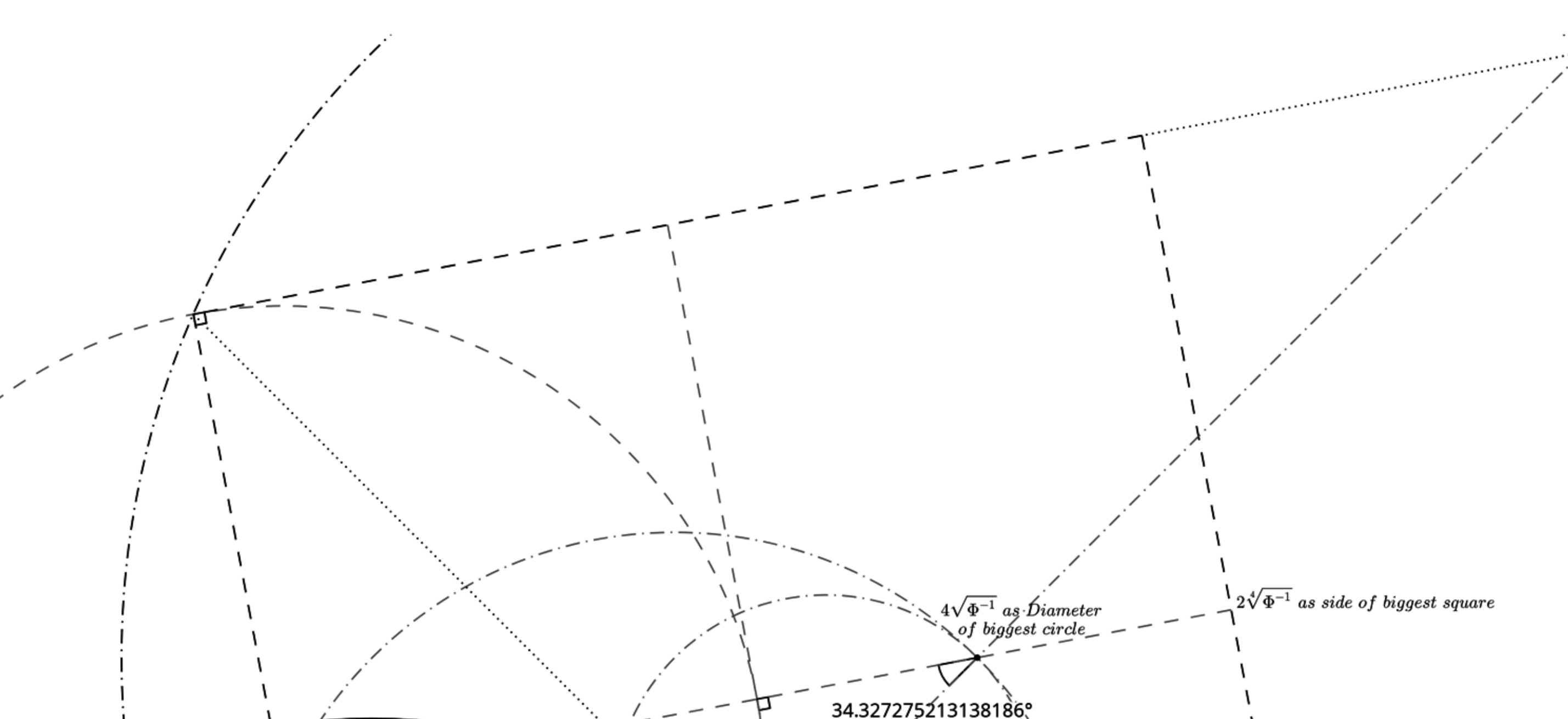
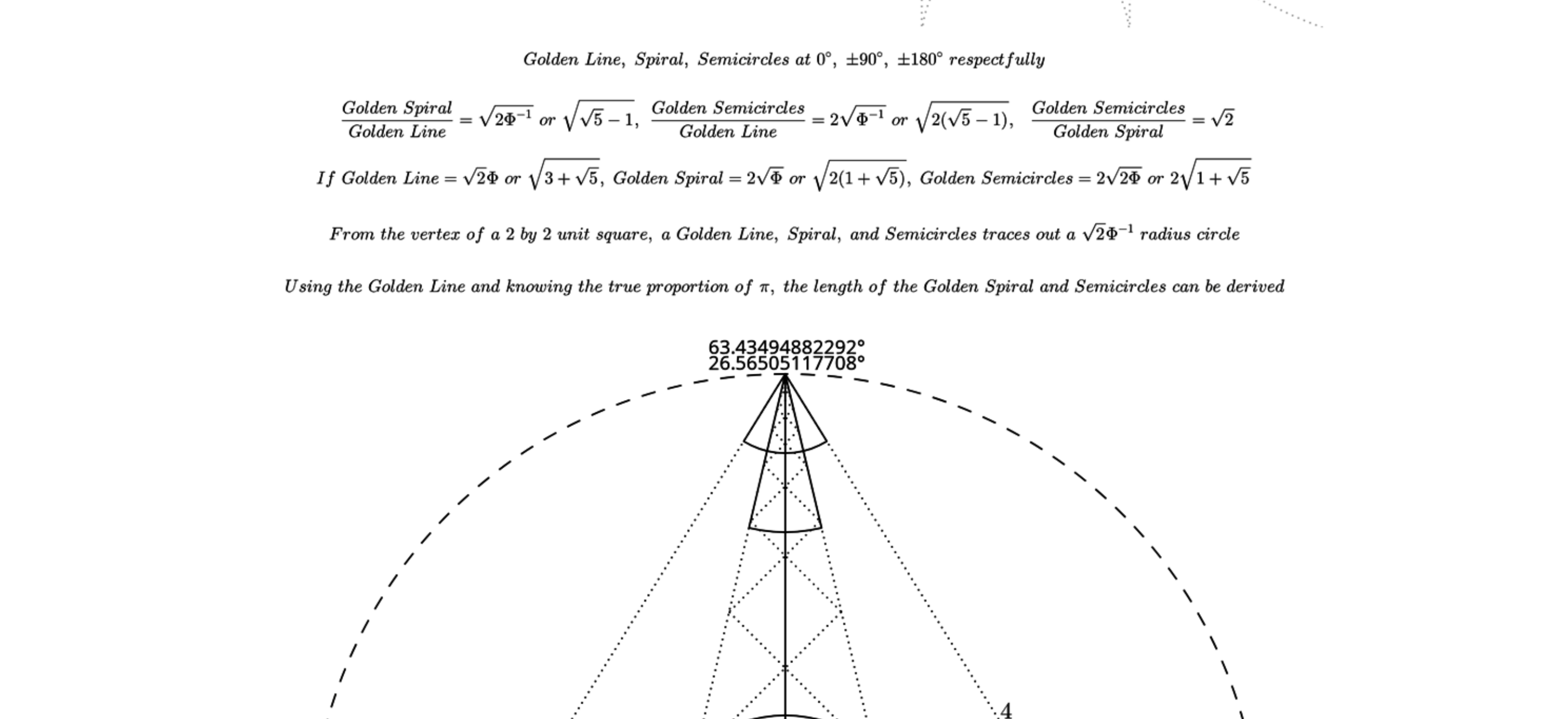
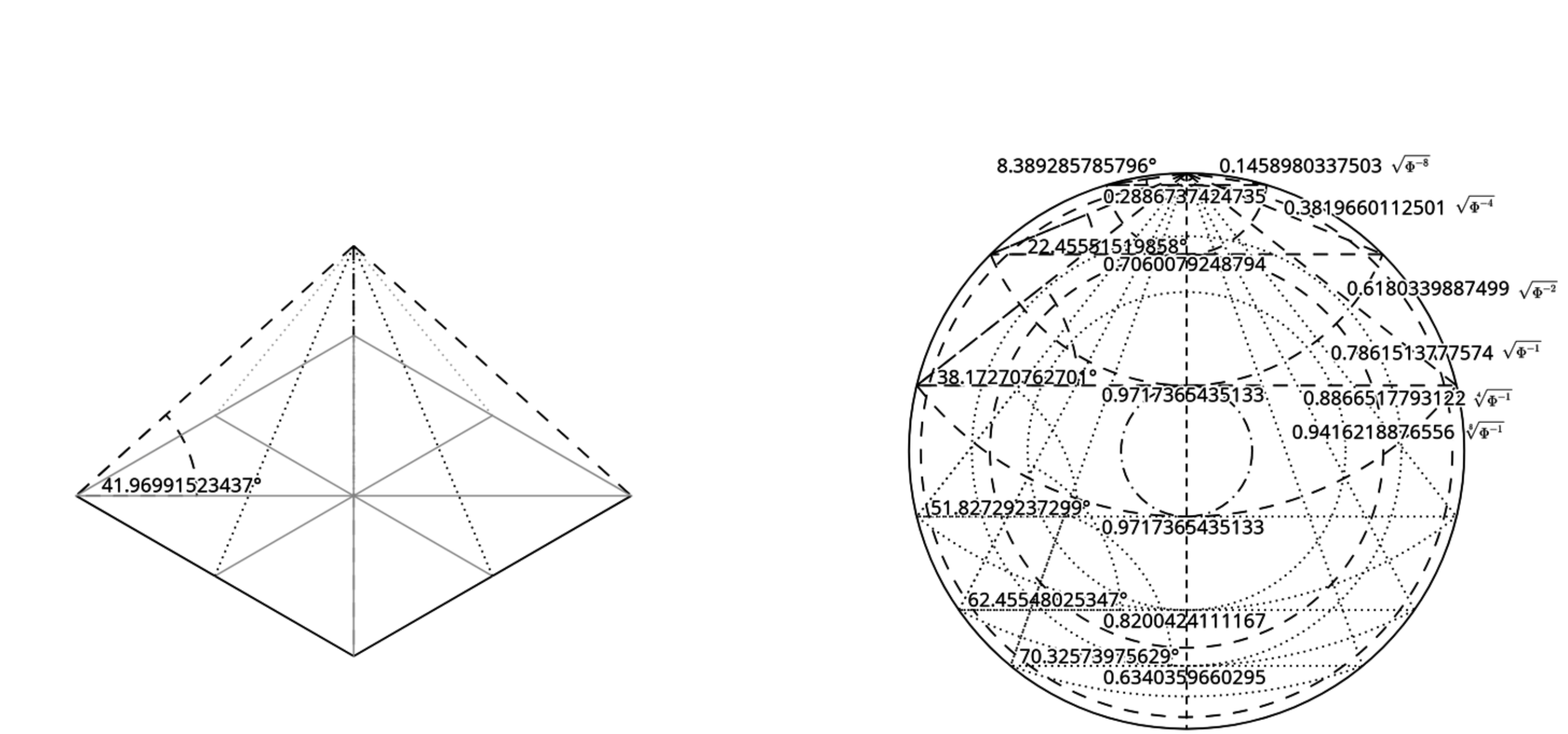
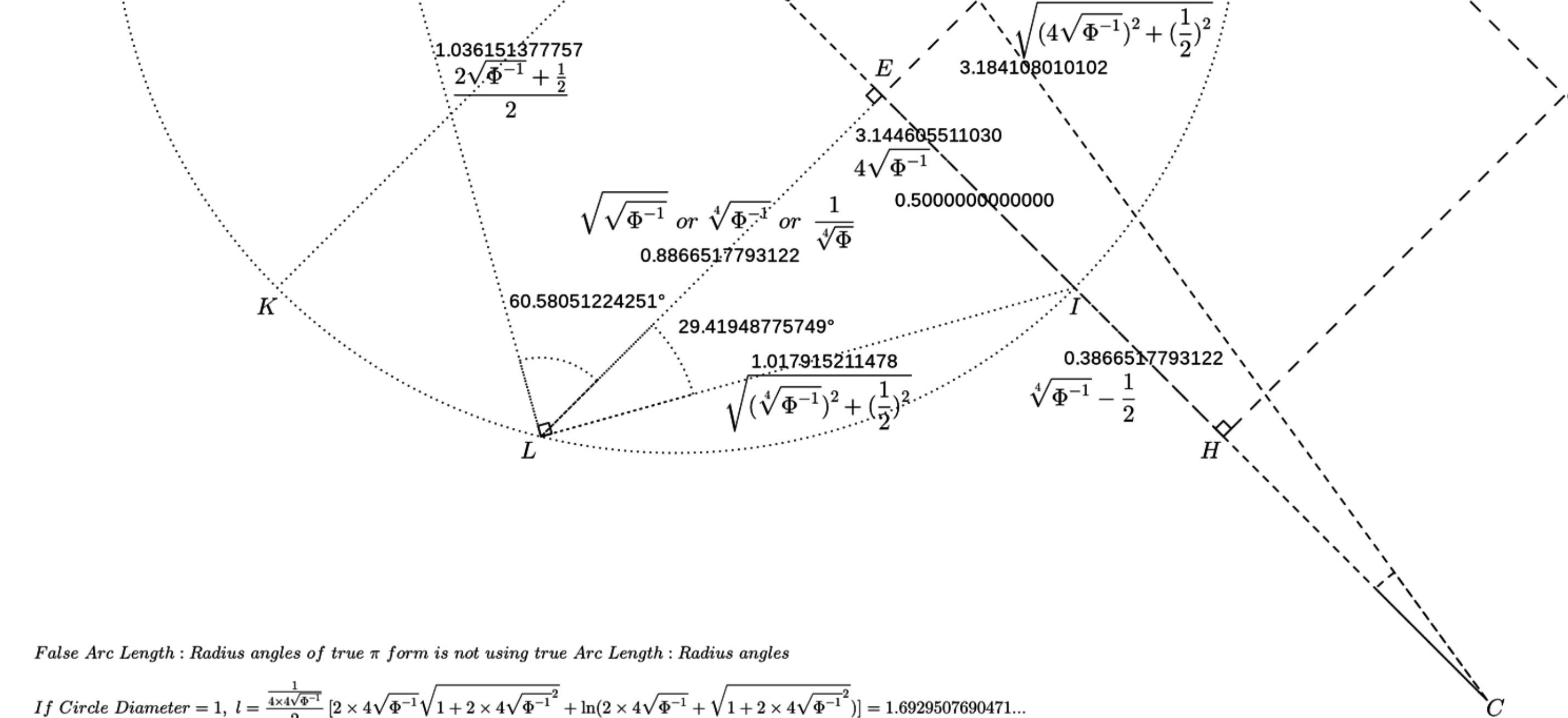
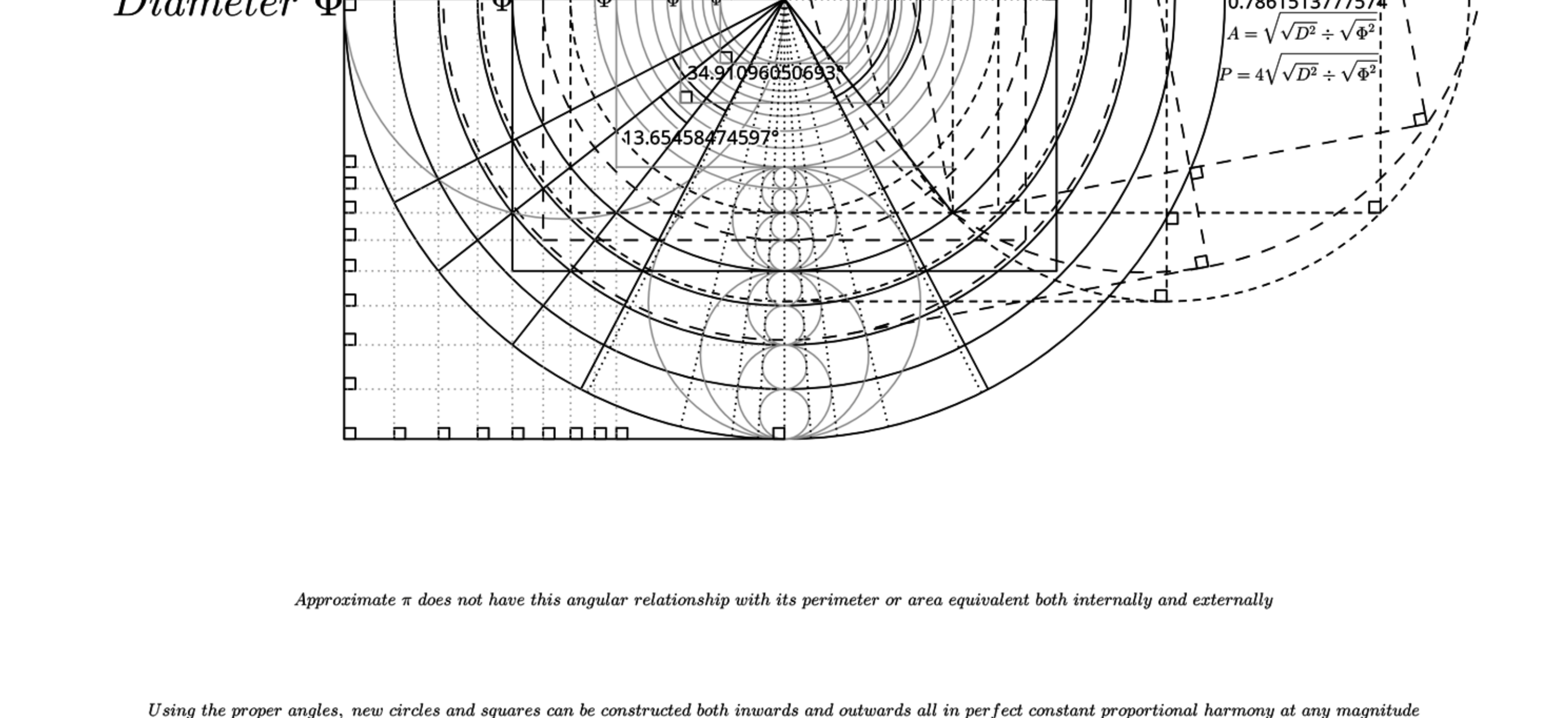
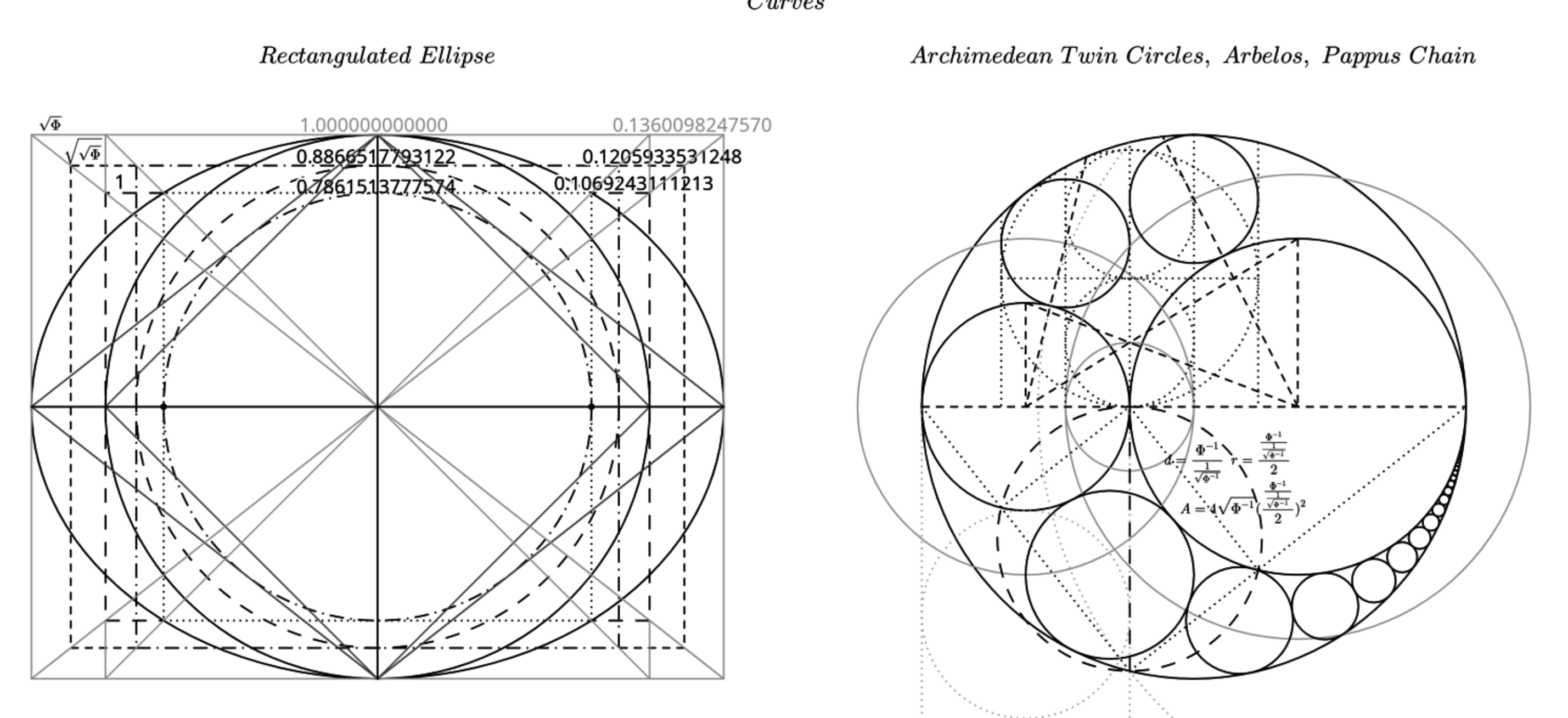
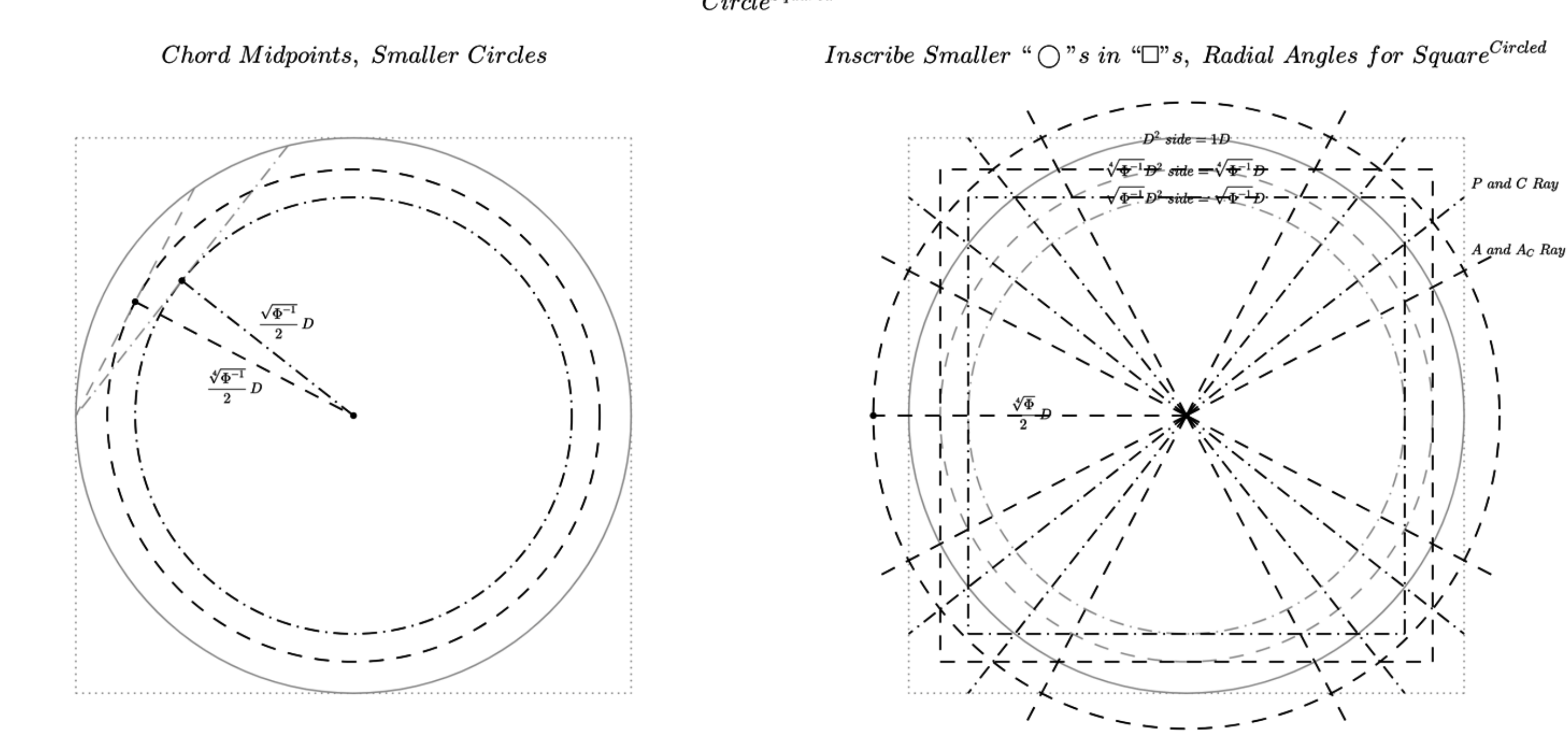
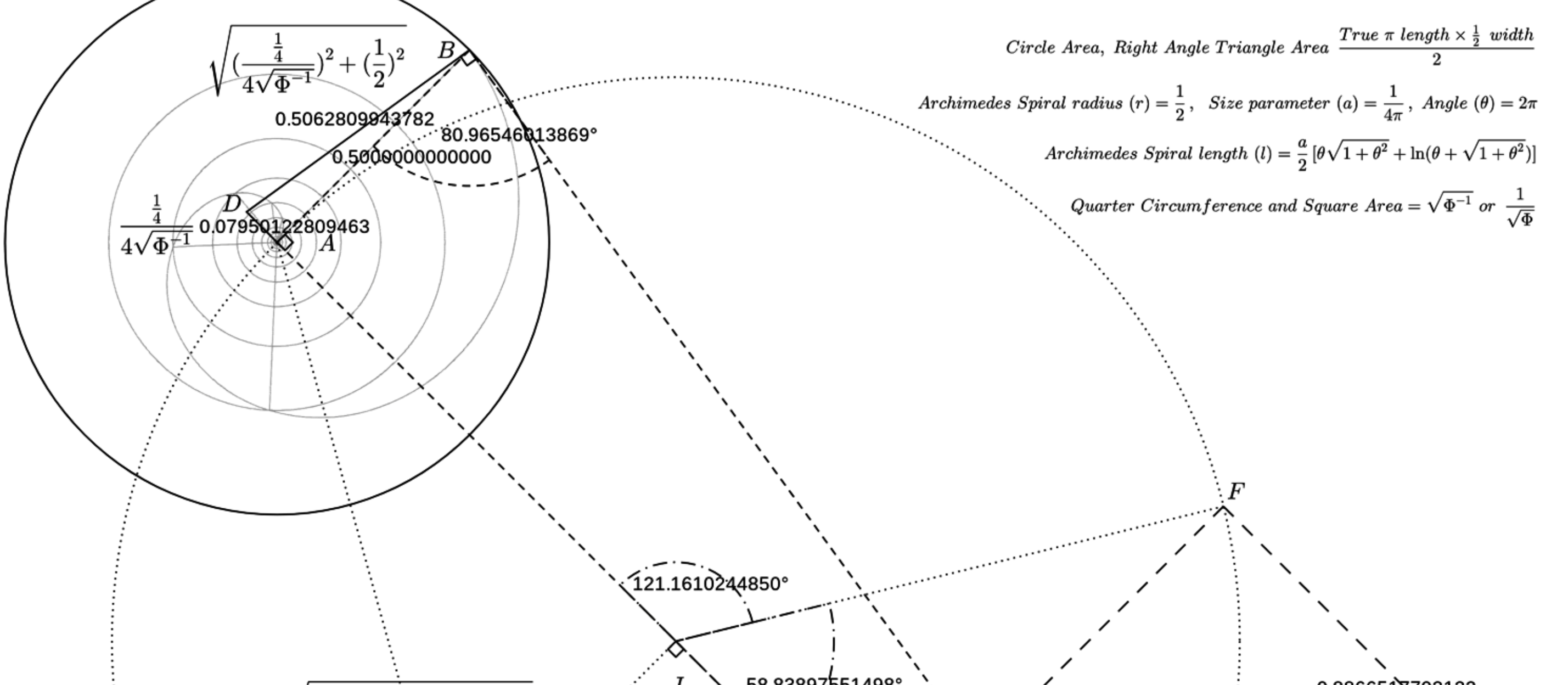
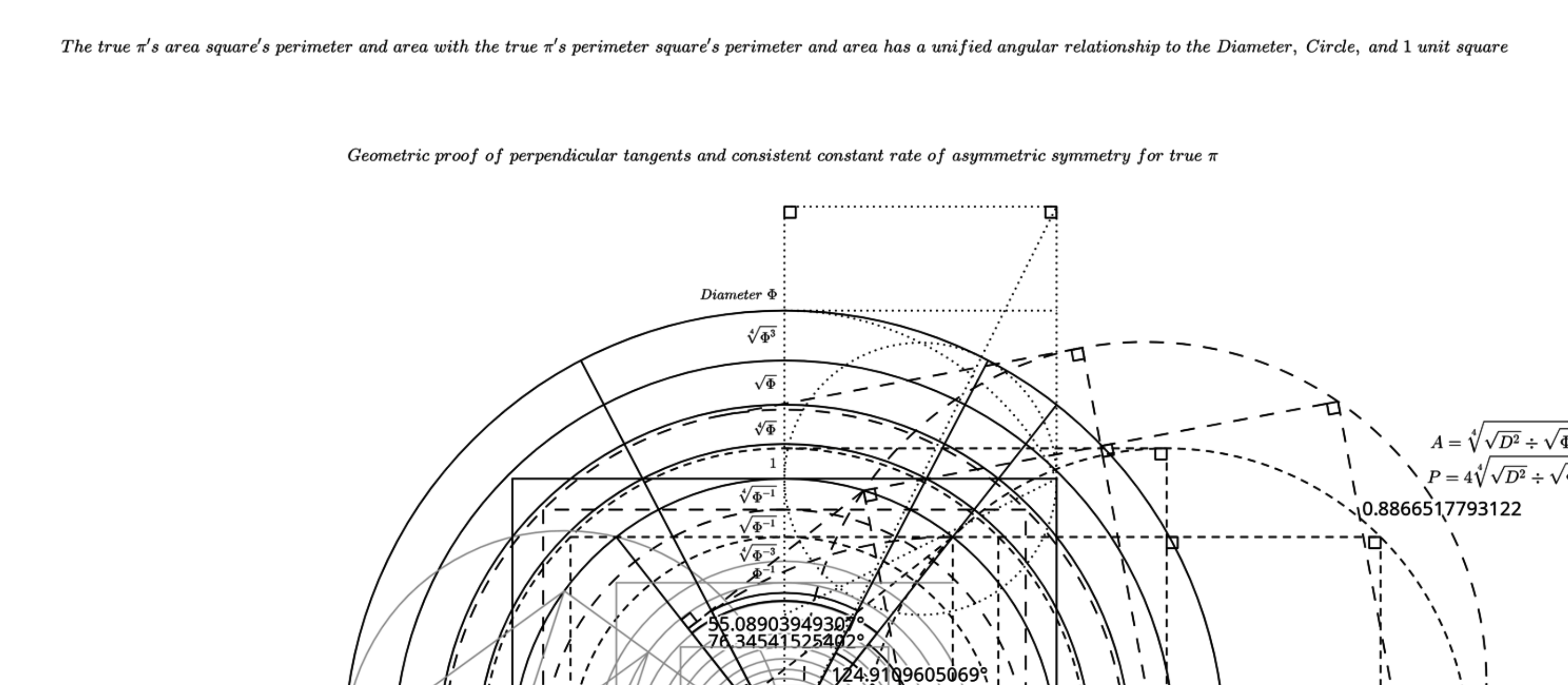
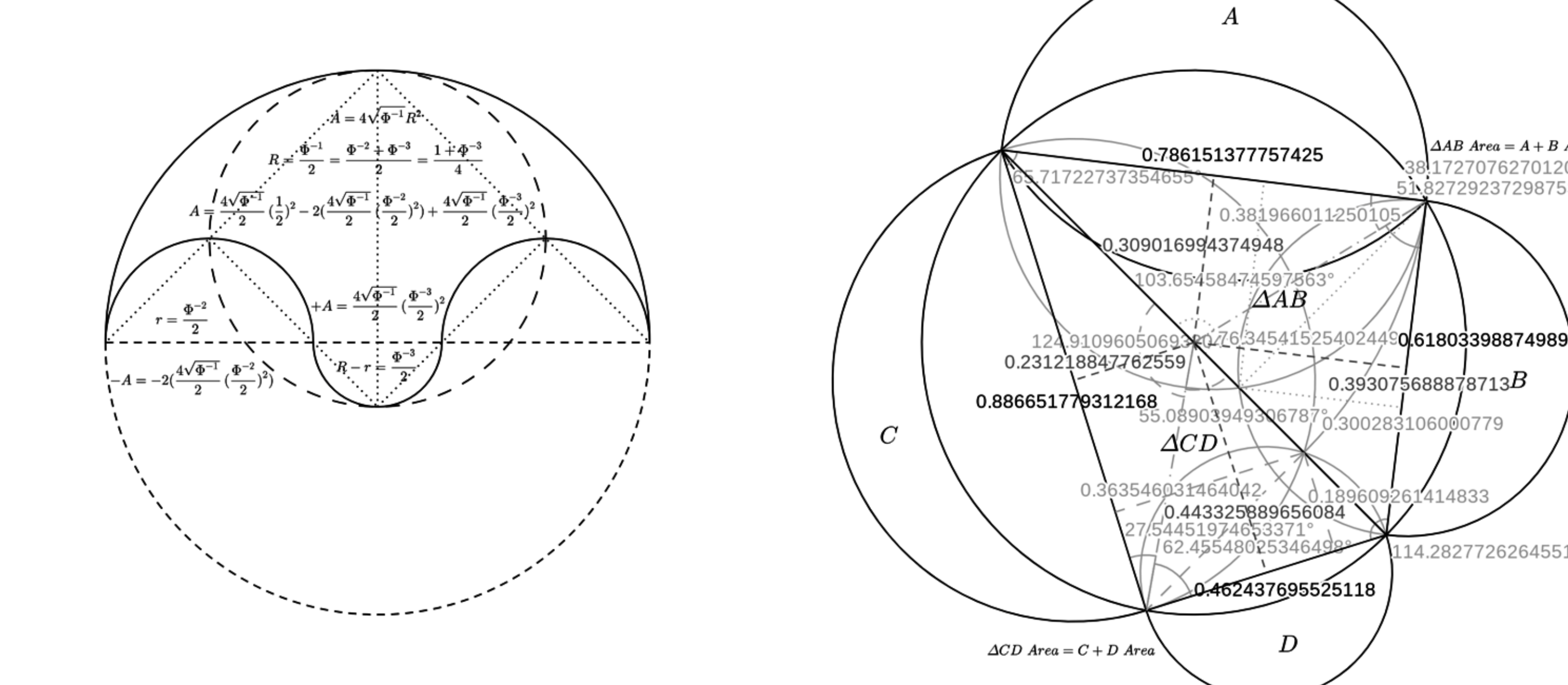
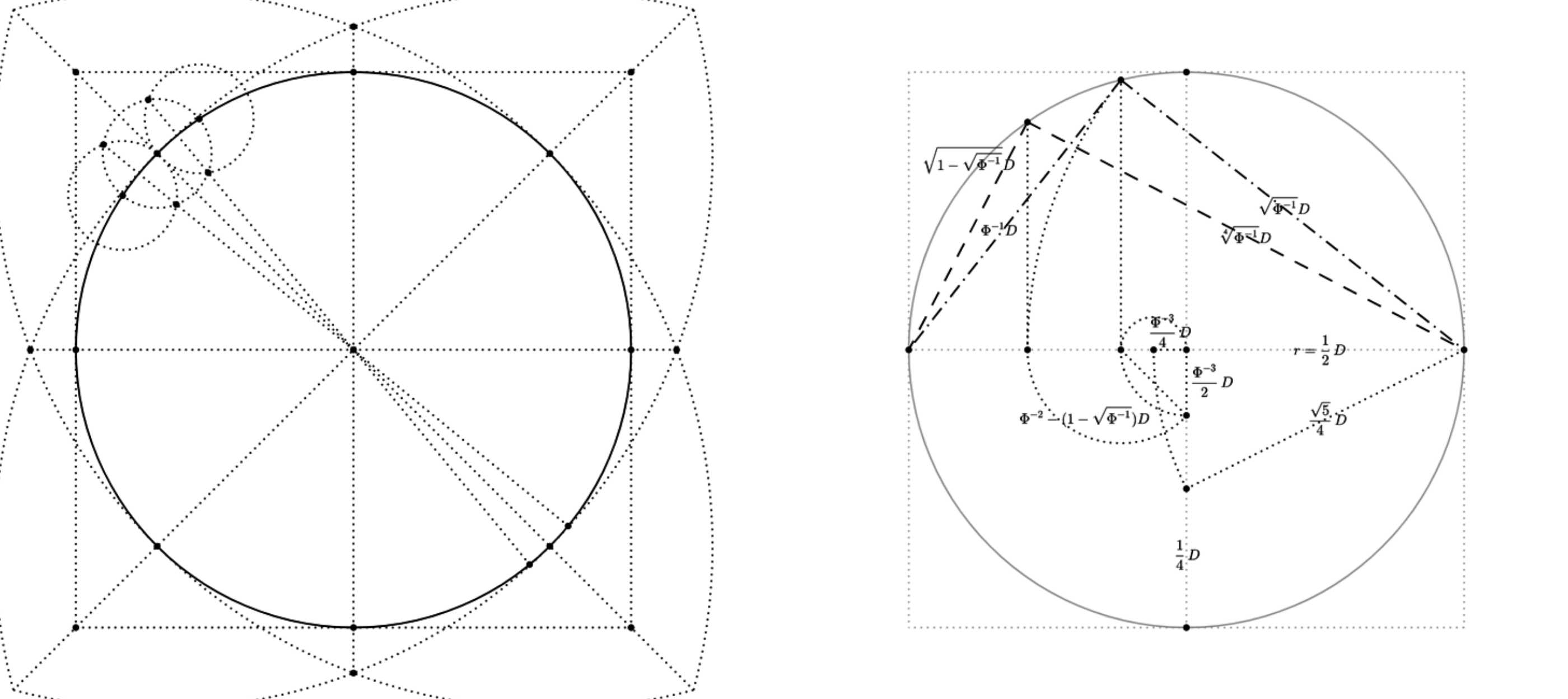

Order of Presence
 A1: Good – Necessary – Principle/One
 C2: Ineffable – Indefinite – Indeterminate/None
 D3: One – All – things/Limit
 B4: All – things – One/Unlimit
 E5: Unified/Mixture/One – One
 F6: Being/Abiding/One – Many
 H7: Power/Proceeding
 G8: Mind/Intellect/Whole
 I9: Act/Reverting
 J10: Noumena/Idea/Part
 K11: All – Soul/One – and – Many
 L15: World – Soul/Prime Matter
 O13: Divided Soul/Individual Souls
 N14: Body/Secondary Matter
 L15: Life/Consciousness
 Order of Absence
 Order of Immanence
 A1: Good – Necessary – Principle/One
 B4: Unlimited – One
 C2: Coalesced – One
 D3: Limited – One
 E5: United – One
 F6: Omitte – Mind
 G8: Subjective – Mind
 H7: Passive – Mind
 I9: Active – Mind
 J10: Objective – Mind
 K11: Nounenal – Soul
 L15: Living – Soul
 M12: Phenomenal – Soul
 N14: Bodily – Soul
 O13: Logical – Soul
 Order of Transcendence

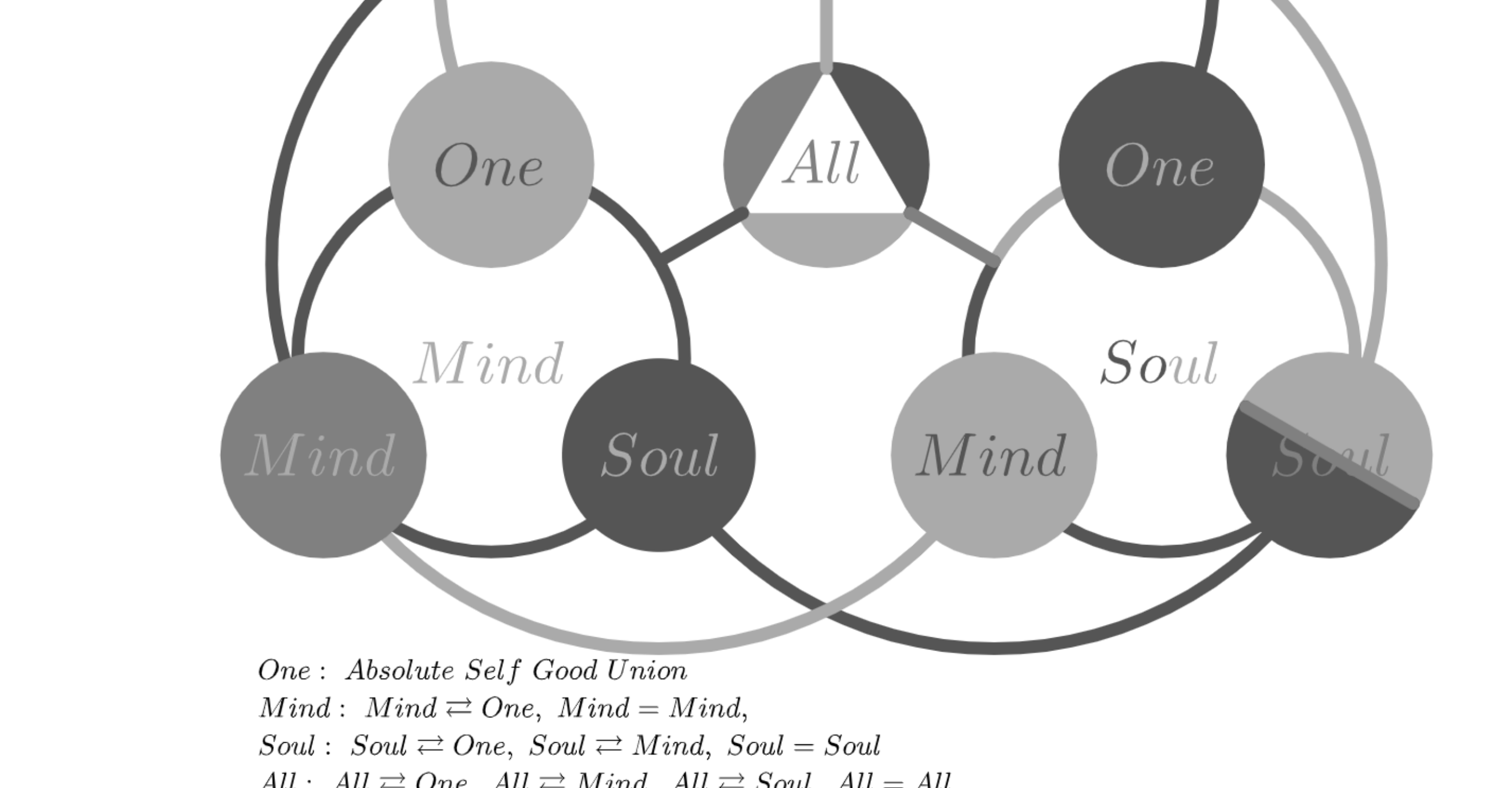
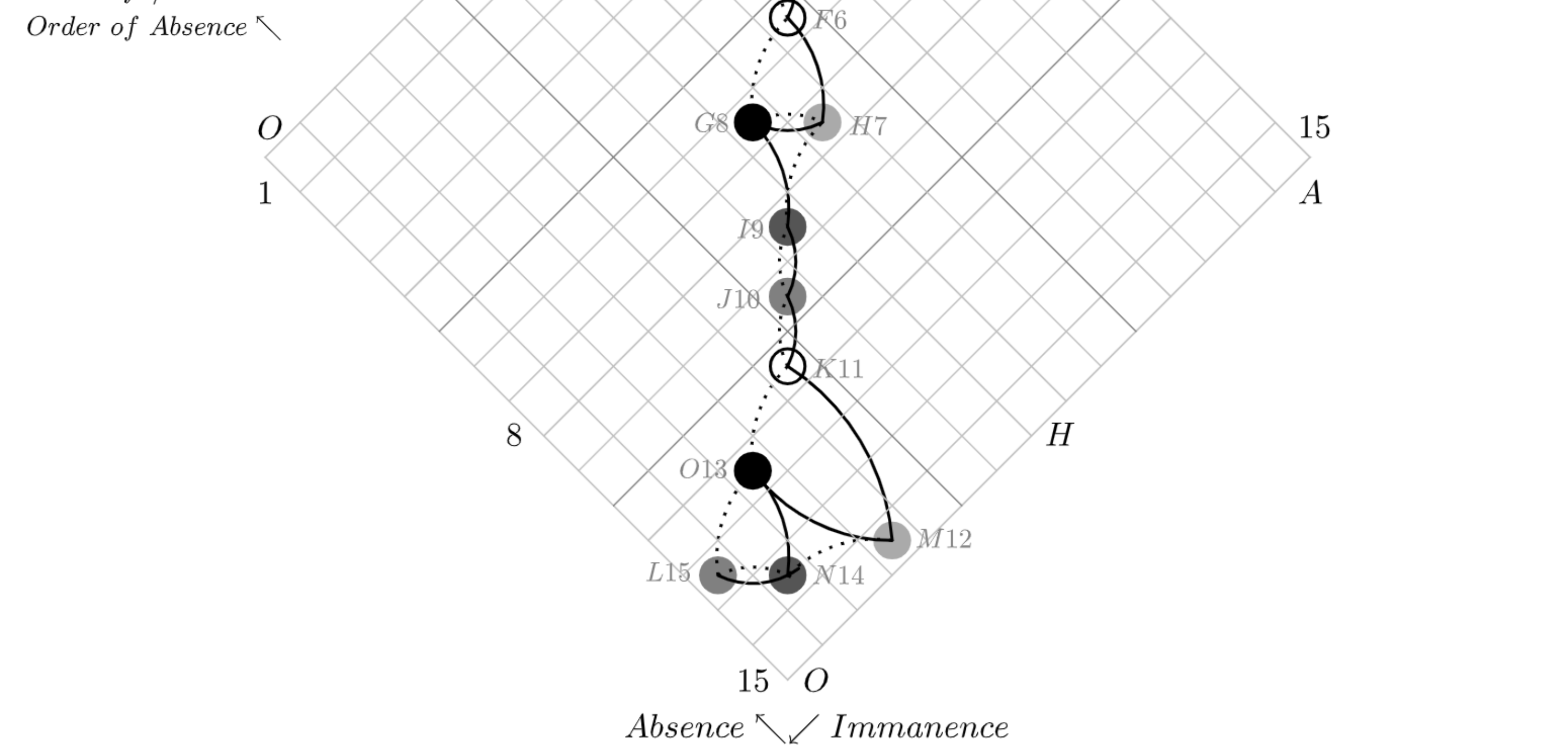

One : Absolute Self Good Union
 Mind : Mind = One, Mind = Mind,
 Soul : Soul = One, Soul = Mind, Soul = Soul
 All : All = One, All = Mind, All = Soul, All = All
 Nought : (One – One), (Mind – Mind), (Soul – Soul), (All – All), Nought ≠ Nought
 Panta Penta

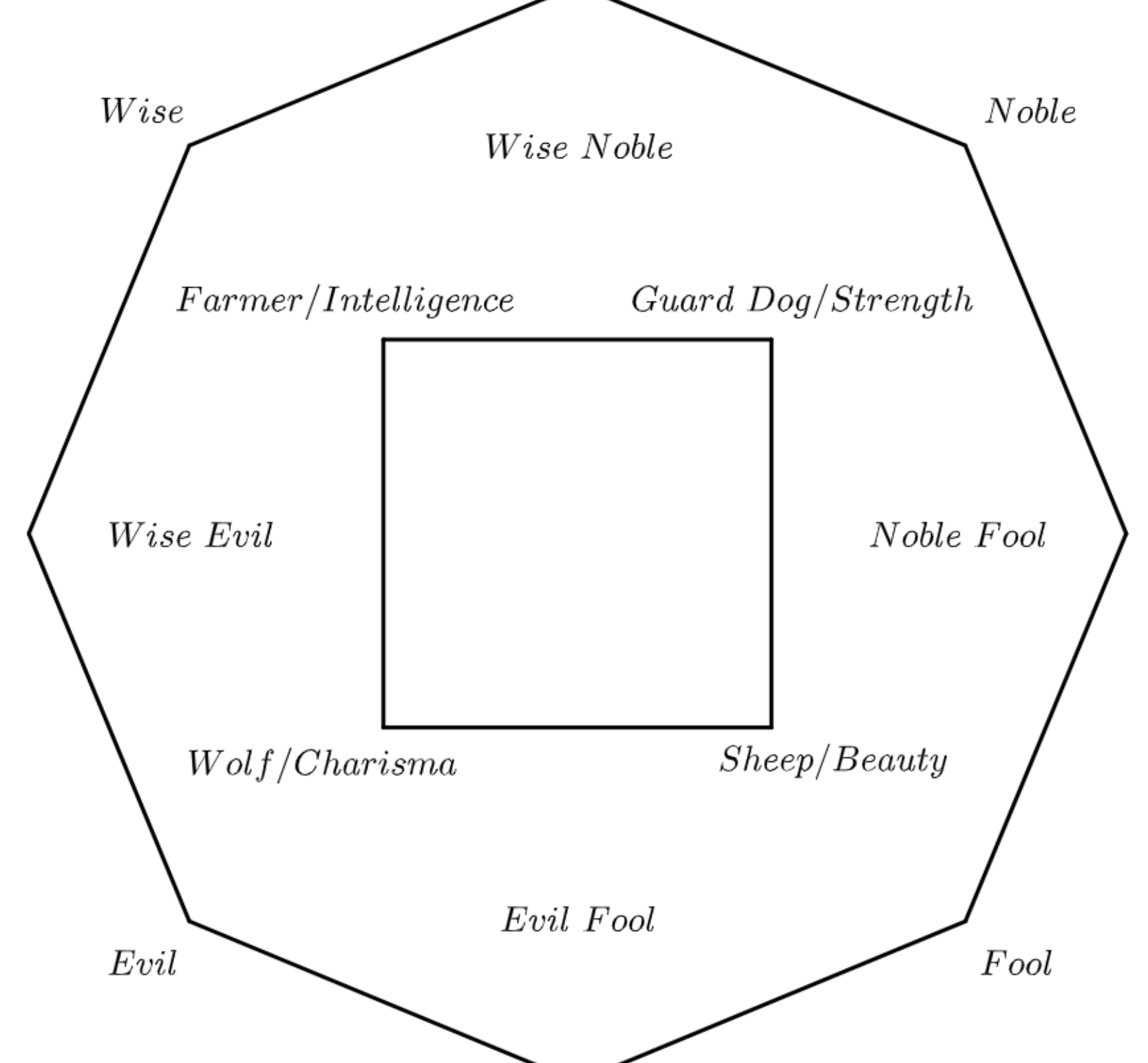

General Life Lessons
 Wisdom
 Know thine Love within Wisdom of the Divine Self above all else
 Seek out noble personalities with noble intellects
 Work smarter not harder towards self sufficiency
 Discernment
 Compared to what? At what cost? What hard evidence do you have?
 Learn about truisms, heuristics, fallacies
 Situational Awareness
 Be aware of your surroundings using discernment
 Trust not many, trust in god alone
 Never take any falsehoods and ad hominems from anyone seriously
 Never be around those bound to fetters that you don't want to emulate
 Redundancy

Have more than one thing of importance in more than one location
 One archive is a backed up backup of the original
 Four Types of Redundancies : Body, Mind, Social, Monetary
 Of the Body : Clean Air/Water/Food/Clothes/Shelter/People/Pets, Hygiene maintenance products, Nicotinic Acid + L – Tryptophan + Folic Acid + Distilled Water(see : homSostasis.com by Dmitry Kats), Trauma Kits
 Of the Mind : Analog and Digital Data of Memories, Knowledge, Wisdom, e.g., Digital Files in Portable SSD, Physical Copies of Nondualist Philosophy Books, Personal Diary
 Of the Social : Family, Relatives, Friends, Communities, Alliances
 Of the Monetary : Tools, Weapons, Ammo, Land, Fuel, Vehicles, Minerals, Crops, Livestock, Networking, Currency, Stocks, Time, Services, Collectables, Miscellaneous Consumables

Diversification
 Diversify life skills
 Preplan to prepare for all tragedies and eventualities
 Diversify Redundancies
 Seek Not Excess

Don't promote trash for anyone
 Don't perpetuate personality cult
 Don't abuse intelligence, charisma, beauty, strength
 Don't go along to get along in being all things to all people by pondering to ignoble personalities and/or ignoble intellects

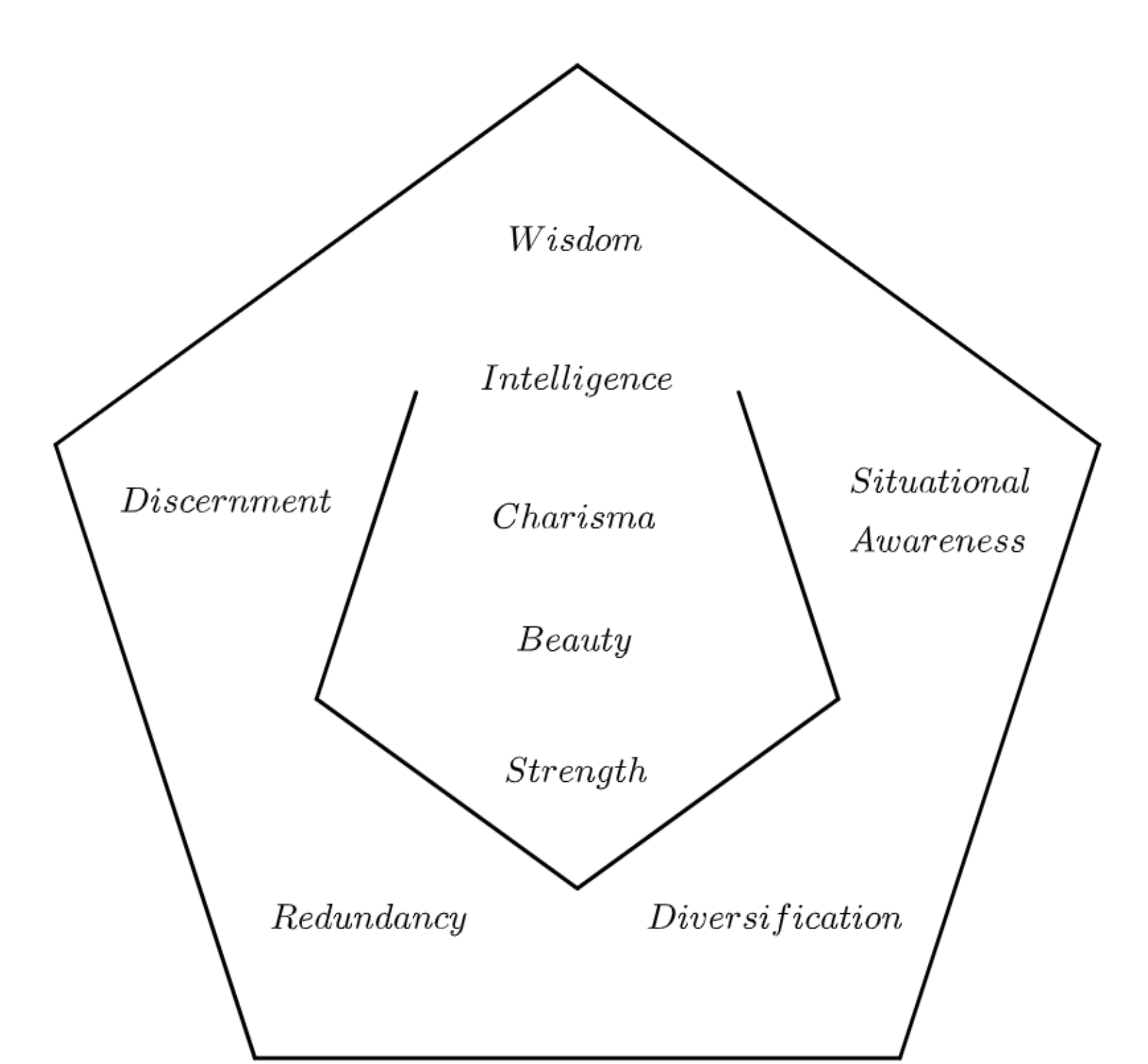

Seek Not Excess

Theophany

φυγή μόνου πρὸς μόνον οὐδὲν ἐξ οὐδενός

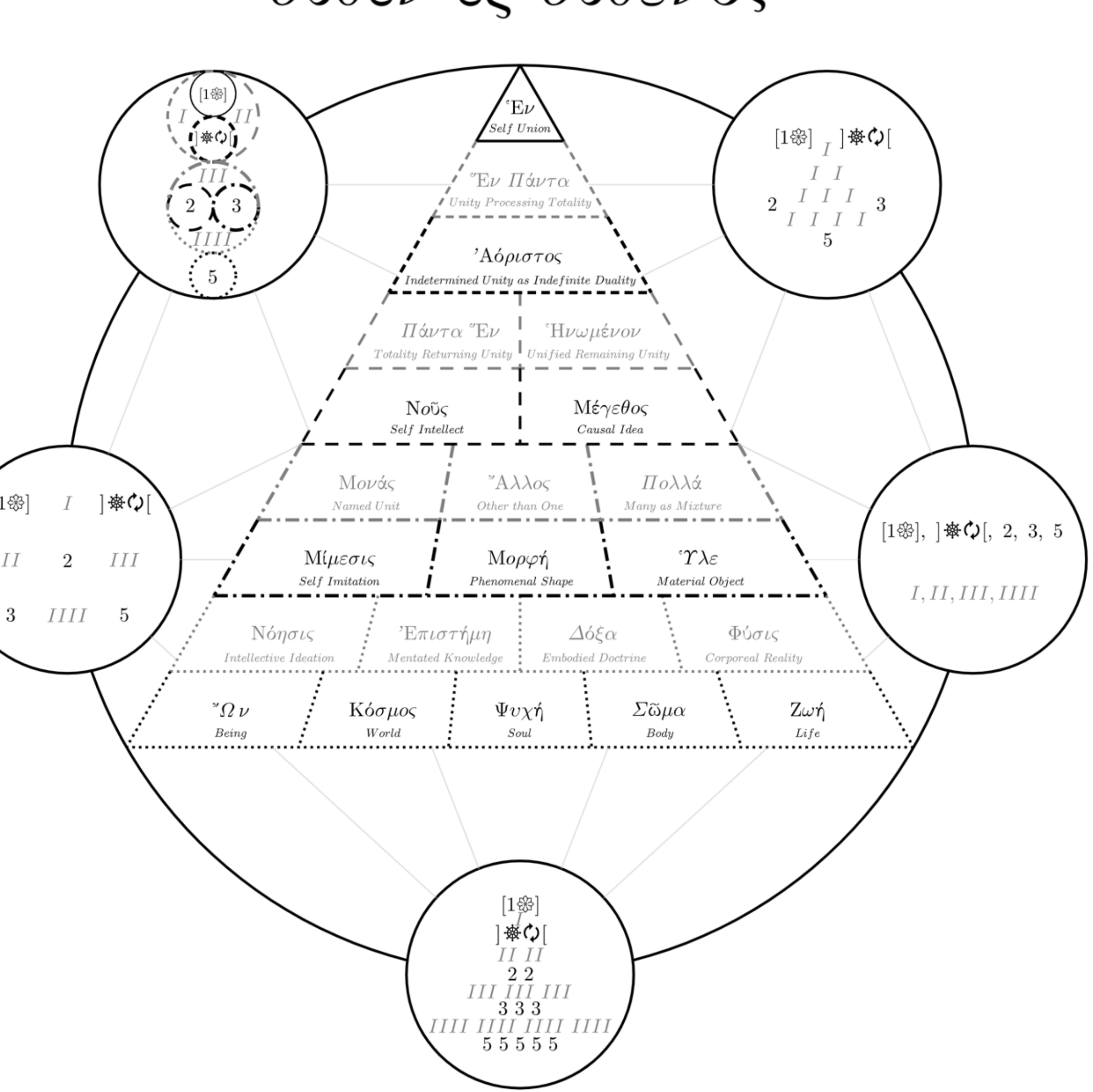

Order of Presence from Top to Bottom, Left to Right, Black to Grey
 A1: Good – Necessary – Principle/One
 B4: Unlimited – One
 C2: Coalesced – One
 D3: Limited – One
 E5: United – One
 F6: Omitte – Mind
 G8: Subjective – Mind
 H7: Passive – Mind
 I9: Active – Mind
 J10: Objective – Mind
 K11: Nounenal – Soul
 L15: Living – Soul
 M12: Phenomenal – Soul
 N14: Bodily – Soul
 O13: Logical – Soul
 Order of Transcendence

Two Lights, Two Darknesses

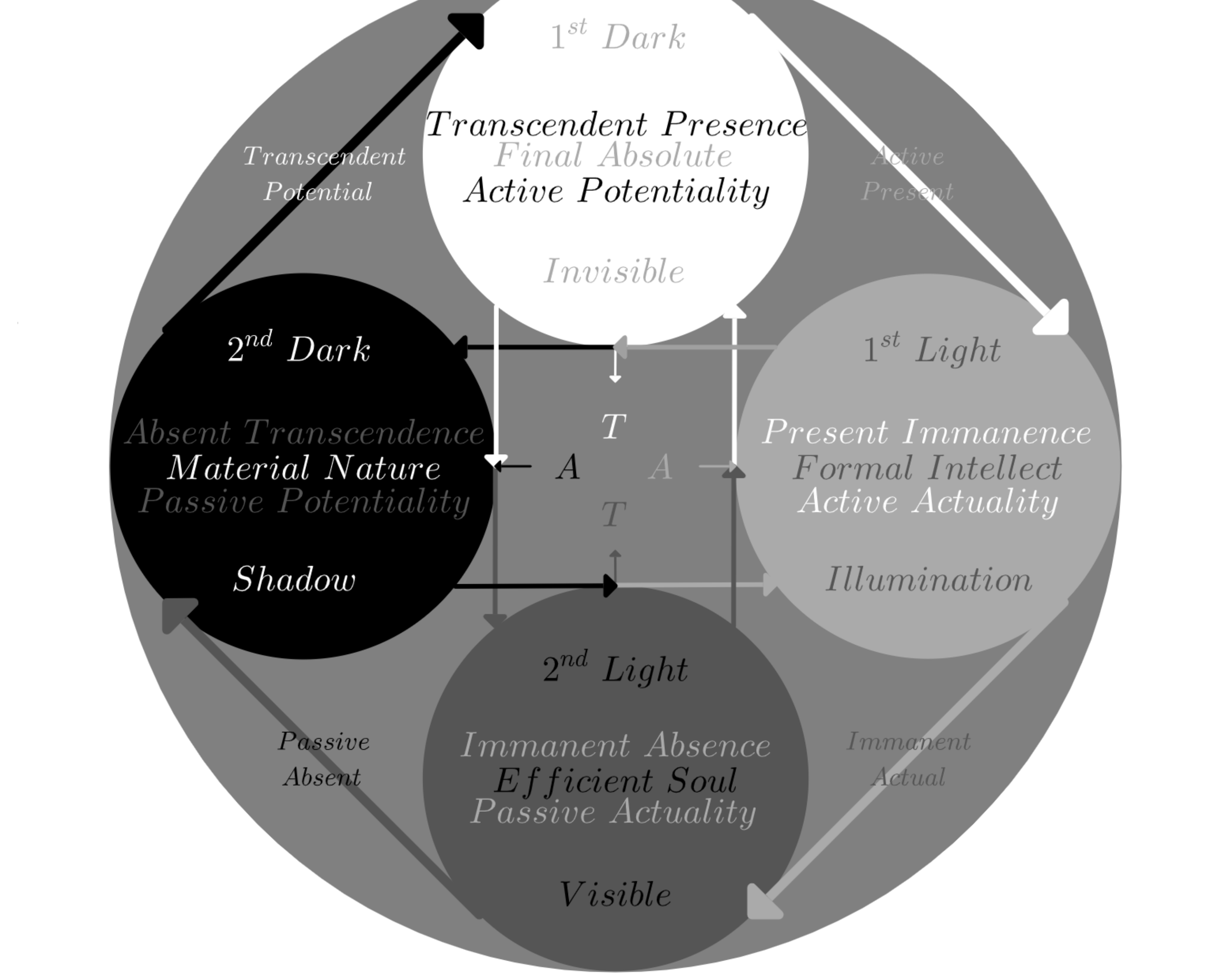

Buddhology Primer

Tattha Atta Va Sarathi = The Soul is the Charioteer

Ekaadharma (One – True – Nature) = Ajata(unborn) / Akhata(undying) / Akhata(unbroken) / Amata(immortal) / Nivata(eternal) / Anakhata(uncut) / Animitta(spiritless) / Anapa(unshakable) / Adakkhamanabba(neither gain nor joy)
 Alpha(S*AN*) / AM(ton/Indistinct) Principle = Self marked/ found pass the Sui(dae/pate) = 2^4+3^2 (AtA) = Atman – Aten/ Atmi/ Atom(Soul)/ Anom/ Anoma/ Hidden One/ Amen/ Anom/ Aten + Ra/ Re – Hidden(One/Sun) Nibbana/Light Due Anakkat(Ah/Without + Akhet(Horizon)) = Anakkat(Necessitate First Attribute susceptible from the One that cannot be in any other way) = Aaristos Dyaos(Without demarcation of duality between First Principle and First Attribute)
 Tat Team Asa(Tat/Brahman)/Hen/Absolute/Aptthon/Unbound/Infinite/Thou/You/Atman/ Are/Ar) = Akam Brahmasmi(I Am That Absolute) = Yoga Citta Vritti Nirodha(Samadhi/Assimilation) is Mind Modulation Subyugation)
 Atta Hi Paramo Pige(Atman is most beloved) = Alkatarana Ananassaran(The Soul is the Refuge with none other as Refuge) = Saranamattano(Refuge in thine very Soul) = Samatta(Alone/void of impurities without defilements is That Soul)
 Alakkara(Light Dyaos) possessing Alkatarana(perception into the unseen wisdom) = Kalpanam Attanam(Light – Self) = Pradhata/Arhatat/ Arjagavakat(Voice true nature of the Buddha + Law)/Sat(Spa)/Mani(Spa)/Bhagava(Lord/Venerable) Anam/ Anon/ Aneni(Hidden One) = Anam/ Ananassata(god/spirit)/ Ananassatipodike(supernatural) = Yakkha(Yaksholquack ray of Light) being = Devata(Supreme God Duality) = Devattabhava(Divine Condition) = Attatta(Radiant Soul)
 Paramattha Amatam Nibbana(Highest aim is Deathless/ Ambrosia Nibbana) = Bhava Nirodha Nibbana(Cessation of Becoming = Nibbana/Unbound/Purification Process) = Nirvatti(Nirodha/Cessation) = Vritti(Perturbation/Modulation)
 Atmananta(Atta + Mano) = Atman(Supreme Extraction of Citta/Vinnana into Higher Realm) = Atman(Deathless Essence/Spirit) = Atta(Soul/True Self)
 Vijjajinamata(Goats of Atta Liberation) = Jata(Light of Citta) = Attanam/Atman = Atmanam/Atman = Atmanam(Soul in Soul) = Sattama(Spirit)/Sattaha(Belonging to Spirit) = Paramattha(Highest Aim/Truth/Perfection)
 Vajrasamvatta(Diamond Mind) = Anassata(Indistinct/Unbound/Infinite) = Brahmadatta(Actualized Absolute) = Cittavimutti(Mind Liberation)/Pannavimutti(Wisdom Liberation)
 Upatto(Upatta)to have attained/raedoff = Atta – gone beyond escaped Sansara) = Tathatta(Atta gone unto That/Brahman) = Buddhatta(Buddha Soul) = Arahatta(Araha/Worthy/deserving/enlighted + Atta)
 Brahmadhatena Attanam(is)of the nature of)) Brahman) = Svabhava(Self Nature/True Being) = Tathagata(Hypostatic Self possessed entity duels in Sarmatha) = Tathagatagarbha(Buddha + Matra) = Buddhadhata(Buddha Principle)
 Tathatata(Steadfast to Soul) = Suppattitthacatta(Superly fixed within Mind) = Tathasathato(Steadfast in True nature) = Suvimuttacatta(Su[thoroughly/Well] – vimutta/Liberated – catta/Mind)
 Appattitthena Vinnana(Unestablished consciousness) = Cittavimutti(Emancipation/Ekoptrope/Liberation of the Mind) = Purvabhava(Purification) + Nibbana(Unbound/No/Upotte) = Jata(Buddha/Shackled) after death)
 Samgok(Samma + Yakkha(Divine Light Spirit Being)) = Mahatta(Supreme Person) = Mahapuriso(Great Spirit) = Atkinnagastana(Deposessed Being) = Vinnavattacatta(Emancipated Mind having assimilated the Soul)
 Jhana(the create is savi)toed(unannned in the fire)to the Uncreate/Thapeti(to burn up) = Samadhi(Samma + ajonjonn) + dhata(rodm of)) = Ekopattitthaa(one pointed of Mind) = Cittasamadhi(Unity – Conjoinment of Mind unto Perfection)
 Patisu(Per)to the Mind away from the Aggregate) = Upanasara(Gathers the Mind within Nibbanadhanga)Ummam(fast Realm of Nibbana)/Amatapadhatapa(Realm of Immortality)
 Citta Viandhava(Purification of the Mind) = Buddhassanaa(Devotee of the Buddha) = Dhammapada(Law of Illumination)/Teaching Form of the Nature of All Things and Phenomena) = Suddhama(Soul/Sanna) = Dhamma
 Sammasambuddha(Supreme Buddha that dwells in Samma Perfection) = Samahassasanna(Disenbody antecedently by Annamata into the Abode of Samma) = Siddhattha Buddha(One who has Per fected Attainment of Buddha)
 Anutara(Un + exalted) Samgok(Samma/Vezus potential Perfection unmani/fold indistibility/Sak/Abode of Indistibility) + Ma/Restover of Supernal Potential of the Hypostata) + Yukta(Yutta/Yoked) Sambodhi(Samma + Bodhi/Wisdom)
 Anagatajinnam(Path to Immortality) = Sammasagga(come and gone within Perfection) = Samatta(True Self Perfection) = Samvattati(Samma Perfection/Vezus matrix of Hypostatic Perfection indistibility) = Nivatatti(Nibbana)
 Noble Ten fold Path of the Anekha(Masterful complete winning of fully ripe in wisdom's Perfection) : 9 Sammanam(Supreme knowledge of Samma Perfection), 10 Sammasamvatti(Supreme release into Samma Perfection)
 Path of Release : 8 Sammasagga(Analysis/Separation from name/obscure of Perfection), 3 Sammatatti(Annamata)Revolutive – Conjoinment of Perfection), 10 Sammasamvatti(Unity – Conjoinment of Perfection)
 Illumination : 3 Sammasat(Legs/ Doctrine of Perfection), 4 Sammasamvatti(Actualization/ Disembodiment of Perfection), 5 Sammasamvatti(Subsistence upon Soul Conjoinment of Perfection)
 Noble Vision : 1 Sammaditthi(Revelation/Vision of Unity – Faj/Immit), 2 Sammasankapo(Determination/Unity – Insight of Perfection)
 Ariga Athhangka Magga(For Noble Path leading to the Abode of Light) = Brahmagama(Path to Absolute) = Hetuvada(because of this im/consentation)/Adhoga(Non Dualism)
 Cattari Arigamagga(Four Noble Truths) : 1 Dukkham(Su/Fering), 2 Dukkhanirodha(Pain Ending Diagnosis), 3 Dukkhanirodhagaminipadapa(Pain Cure in going unto Return to the Light)
 Citta : Noun, Mind, Basis for Dhamma, Superior Path, Reconciliation, Parinibbana, Non aggregate Noumenal Subject within Immortal Realm is Per fected, Purified, Tamiless, Non clinging, Emancipated, Highest Absolute, Soul

Avijja(Anan/Agnost) of Atta, Ignorance/Neoscience, First for Paticcasamuppada(Dependence Origination/Contingent Manifestation) = Citta + Avijja(Include/Incoherent/Mind)/Tanha(Agitation/Cravings)
 Patisamboddi(Reestablished Mind) upon Phassa(Contact) = Thito Vinnana(Immersed/Established consciousness) = Patisamboddivinnana(Reestablished consciousness)
 Manas(Mote/Media/Manifestation/Thoughts of the Mind) = Manasasatima(Object free/Ingresses itself) = Catti(Active mind/Armmannan/basis for vinnana[consciousness] to find a foothold in nanavajjapajpsychophysical)
 Cittakara(Mind to Make) = Cittabhatta(Mind made puppet) = Attakara(Soul veener) = Attabhava(Self willed becoming/genesis)
 Vinnana(Unknowing/Consciousness/Mental Mechanistion/Vire/lectre) = nanavajjapaj mind(on account that it discerns) = Anicca(Impermanence)/Dukkha(Suffering)/Sunnato(Empty)/Anatta(of/less)
 5 More Aggregate deemed Anatta : Kattika(Cell/Body – Cell), Anarabakha(Natural and Final), Anabhava(Diagnosis), Anabhavicoabakkhatti(Diagnosing, Impermanent, and Su/Fering), Sabbo(Khands/Aggregate/the all)
 12 More Aggregate deemed Anatta : Manas(Mind), Cakkha(Eye), Sota(Ear), Ghana(Nose), Jivha(Tongue), Kaya(Hand), Mano(Cakkha) + Sampassas(Cognition/Vinnana/Formation), Raso(Lust), Devaro (Deities)
 Pancaakkhandha(Five Heaps/Aggregate) deemed Anatta : Rupa(Rem), Vedana(Feeling), Samma(sperception), Sankara(impulse/mental fabrication/repertories/phenomena of Khandha/Matter) and Sabbo(Matter), Vinnana(consciousness)
 Namarupa(Psychophysical name and appearance) = Saviannasakko(body with its consciousness) = Anatta(Not the Self/Soul = object/phenomena) = Na Mevo Atta(these are not my Soul/True Self) = Papam Attama(Foul – self)
 Mara(Evil King of Death/Mimesis/Eikon of empirical personage) = Namurupo Anattati(Name and appearance is self/less/persona non grata/Non Person)
 Peta/Sampajama(Peters) : Delusion about Anatta, Doubt of Buddhic Truth, Superiorism in Asceticism, Sexual desire, Harlot to fellow men, Loving life on earth, Desiring life in heaven, False pride, False self righteousness, Avijja
 Kammapatha(path of good deeds) = Samsaracakkhava(continuous perpetrating being) = Bhava(Becoming) = Samasara/Samsarati(round of Dukkha and Jati/irth renewal) = Panahavatti(Transmigration/Palingness/goinn becoming)
 This world is carried on by a Dvayopattittha(Duality) = Suddha/Bhava/Sasattasaddha and Andeva/Vibhava/Uchedavasin
 Suddha = Sat dithi(view of being) = Attithi(views of Sabbon Attithi(the all is entirely) and/or Sabbon Ekattani(the all is one's Soul))
 Anudha = Sat dithi(view of nonbeing) = Natthithi(views of Sabbon Natthithi(the all is ultimately not) and/or Sabbon Pathathat/materialism/the all is many composite corporeal atoms/particles)
 Natthika(Nothing/Merit) = Natthathat(There is Nothing/not/obj. Atta(Soul)) = Natthaditthi(Natthika view) = Uchedavada(Anti/fundamentalist/Annihilationist)
 Vriata(Soditas/view of nonduality/unsubstantiality)) = Natthiko(Nihilist) goes to terrible Avici(hell)

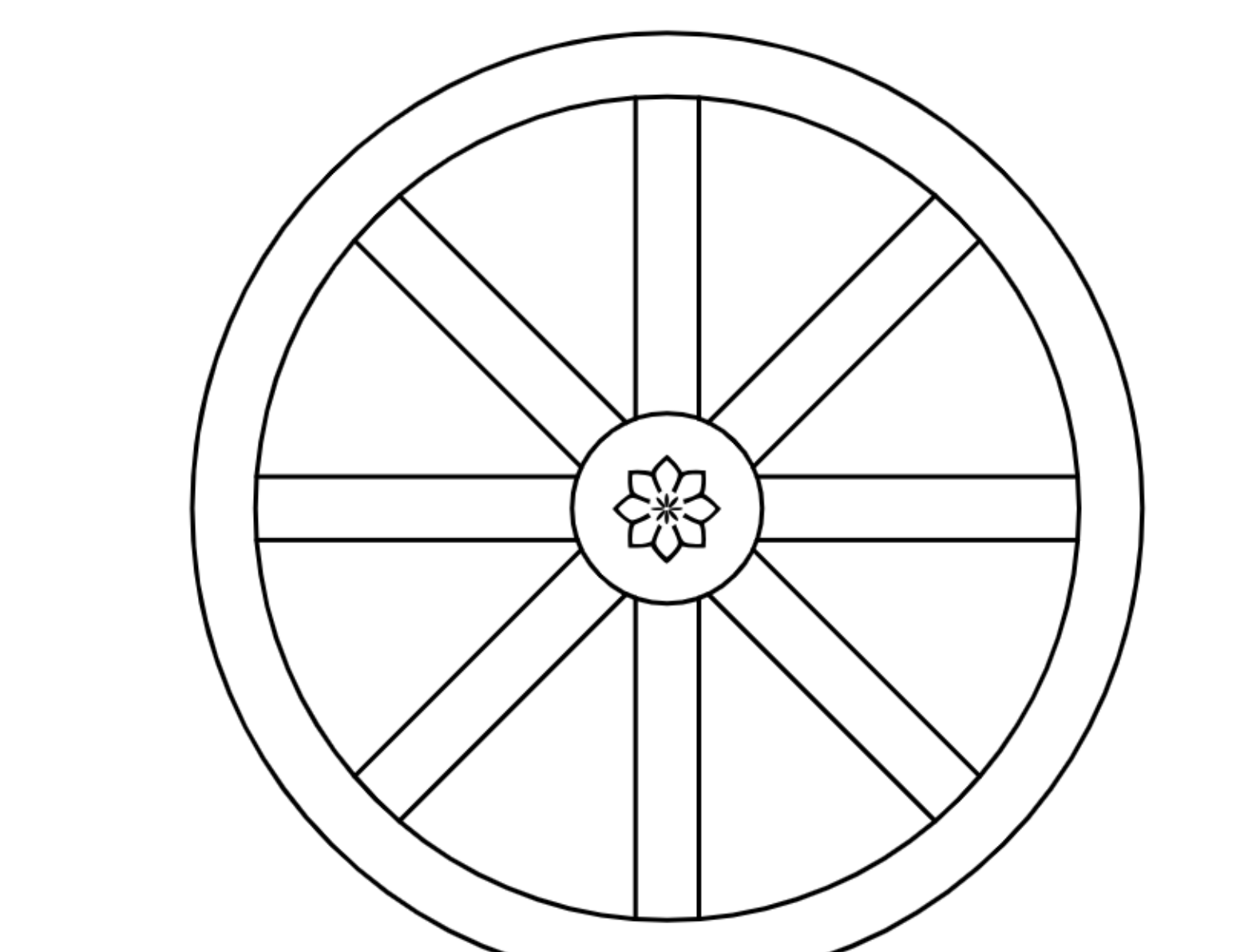

Ambrosia [10]	Arke-Apoteia [10]	Apoteia-Anake [1]	Anake-Arke [10]	Henosis	Thromenon/Henosis (Hen Panta +1))	Panta Hen (-1))	Tolma Hen + (Phi)	Eidos Epagoge (-Phi)	Kosmos Noetos Migma Phi
Lethe [10]	Aperthatos-Adoristos [10]	Adoristos [10]	Adoristos [10]	Aaristos Dyaos	Hen On Adoristos (Homomom x 1))	Hen On Adoristos (Homomom x 1))	Nous + (Phi)	Mimesis Aithes Phi	Kosmos Aisthetos Hen + (Phi)
				Nous	One to Many Many	One to Many Many Many	One	One with Many	Matter
1st Point				Phi Greater	1	1	1	Phi 3rd Cut	1/Phi 2nd Point
				One Many	Nous Purified	Equal Unestablished	Unity	Lesser	
				One to One	One to One	One	One	Many	

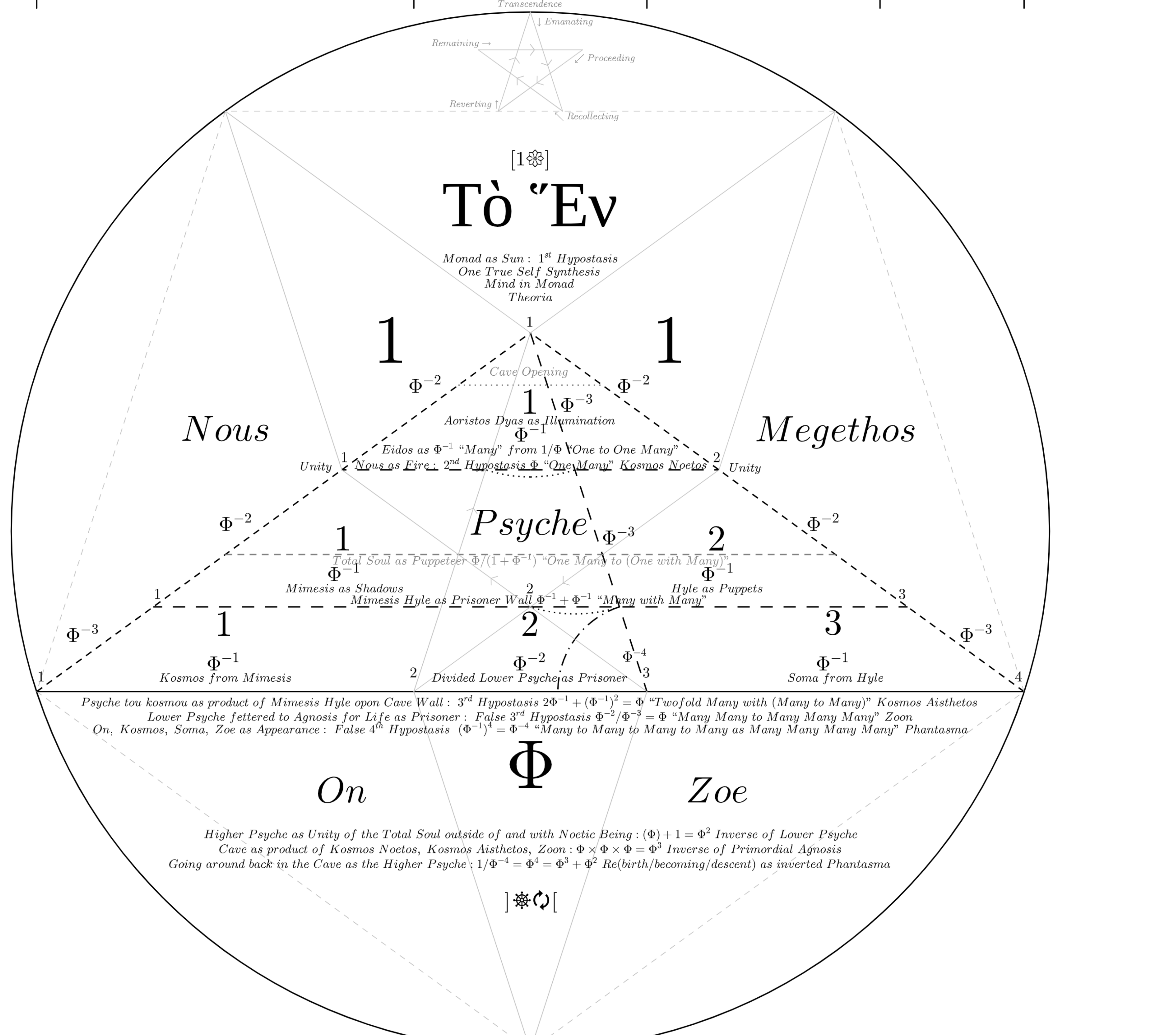

Plato's Republic 509d – 511e, Euclid's Elements V.12, Plato's Republic 514a – 521b
 Phi-infinity = 0, Phi^-3/2 approx Phi, Phi^-2 approx 18, Phi^-1 approx 54, Phi^2 approx 108, Phi^3 approx 144, Phi^3/2 approx 180, Phi^2 approx 216, Phi^3 approx 360
 Multiples of 5, 10, 20, 40 – fold Rotational Symmetry Angles in 360 Degree Divisions in Base 10 are Digital Suns divisible by 9 and Digital Roots of 9
 Ratiocitative Objective Negation culminates into Illuminative Subjective Synthesis above the Aporthotes, beyond the Porosima of the Agathon as Ambrosia away from the Lethe of Palimpsest has come to know Nature
 In the 1 – 1 – Phi Triangle, there's one Phi, two 1, five Phi^-1, four Phi^-2, fifth Phi^-3 found chaste of the Monad while Tolma is tachyotically substituted into Phi^-4 out of Agnosia by Ananke of Aaristos Dyaos as false excessive sixth Phi^-4

Phi - Tolma (Balance/Andacity)/Allo(Other)/Agnost(NoScience), Phi - Athar (Substrate)/Psyche(Soul) ton kosmon(Word)/panta(Total), Phi - Eidos(Ideal)/Mimesis(Imitation)/Hyle(Matter)/Pala(Many)/Megethos(Magnitude), Phi - Pan(All/Totality/Excess)/Pentade, Phi - Aaristos Ynas(Hen On(One Being), Phi - On(Being)/Eos(Life)/Nous(Hen Pala/Mind), 1, Phi - Mimesis(Imitation/Andacity/Irradiation)/Hen(One)/Atheos(Unity)/Henosis(Union), Phi - Arke(Principle/Truth/Ineffable), Phi - Aporthatos(Unfathomably Ineffable), Phi - Anake(Necessity/Inevitable), Phi - Aaristos(Indefinite), Phi - Retroductive, Phi - Abductive, Phi - Inductive, Phi - Adoristos(Indeterminate)/Circumductive